



Compatte e confortevoli, le sedute Decanter sono progettate per garantire un'elevata resistenza del fusto. Le giunzioni della struttura in legno massello sono unite, oltre che da un perno, da una fresatura che aumenta l'area di incollaggio, favorendone la tenuta.

Compact, comfortable, Decanter chairs are designed to ensure an extremely hard-wearing frame. The joints of the solid-wood structure are milled to increase the surface area of adhesion, thus enhancing their grip.



Il marchio della gestione forestale responsabile



Decanter Lazy

design by Studio DINN!



Dimensions/Dimensioni

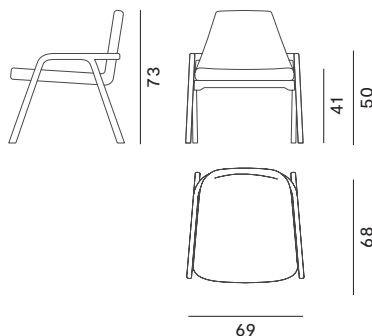

Solid ash frame
Solid oak frame
No removable upholstery

Telaio in frassino massello
Telaio in rovere massello
Tappezzeria non sfoderabile

L 69 × W 68 H 73

Max. per box/Max. per scatola:

1 pc./1 pz.

Volume/Volume:

0,47 m³

Gross weight/Peso lordo:

ca 12,00 kg.

Box size/Dimensioni imballo:

780×720×830 mm

COM: 1,10 m H 140

In case of fabric supplied by the customer, please contact us to verify the production feasibility prior to the start of the order. Confirmation of the amount of fabric needed comes confirmed on offer or order confirmation. / In caso di tessuto fornito dal cliente, vi preghiamo di contattarci per verificare la fattibilità produttiva precedentemente all'inizio dell'ordine. La conferma della quantità del tessuto necessario viene confermata su offerta o conferma d'ordine.

Designer: Studio DINN!



DINN! is an innovative player in the design field, an internationally active team whose projects apply the Design Insighting Process®, a methodology blending strategic vision with creative intuition. DINN! è una realtà innovativa nel campo del design, un team attivo a livello internazionale con progetti che applicano il Design Insighting Process®, una metodologia che integra visione strategica e intuizione creativa.

Woods/Legni

Ash/Frassino



White Ash
Frassino Bianco



Natural Ash
Frassino Naturale



Dark Wengè
Ash / Frassino
Dark Wengè



Walnut Ash
Frassino Noce



Black Ash
Frassino Nero

Oak/Rovere



White Oak
Rovere Bianco



Natural Oak
Rovere Naturale



Oak Dark Wengè
Frassino
Dark Wengè



Walnut Oak
Rovere Noce



Black Oak
Rovere Nero

Fabrics/Tessuti

Cat. A

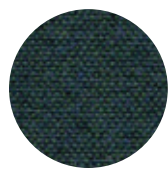

Main line flax
+41 colors/colori



Natur Wool
+28 colors/colori

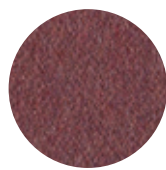

Nord Wool
+21 colors/colori

Cat. B

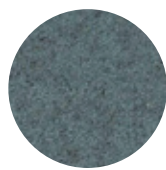

Blazer
+49 colors/colori

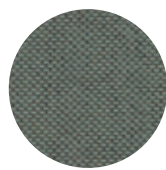

Re-wool
+21 colors/colori



Synergy
+75 colors/colori

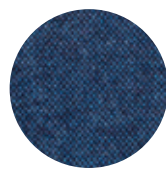

Wolin
+47 colors/colori

Cat. C

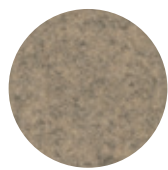

Divina Melange 3
+38 colors/colori

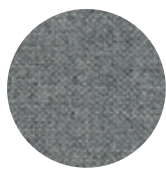

Hallingdal 65
+58 colors/colori



Molly 2
+15 colors/colori



Remix 3
+72 colors/colori

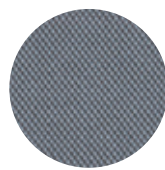

Steelcut Trio 3
+54 colors/colori

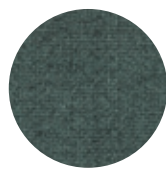

Tonica 2
+39 colors/colori

Warnings/Avvertenze

Indoor use only

Avoid standing on the product;
Do not use the product as a ladder;
Do not swing or rock on the product;
Do not hang weights on the armrests or protruding parts; Avoid any improper use that does not comply with the correct one;

Prodotti per interni

Evitare di stare in piedi sul prodotto;
Non utilizzare il prodotto come scala;
Non oscillare o dondolarsi sul prodotto;
Non appendere pesi sui braccioli o parti sporgenti; Evitare qualsiasi uso improprio non conforme a quello corretto;

Recovery Start/Smaltimento

At the end of its use, the product must be destined for recovery according to the ordinary disposal channels.

Al termine del suo utilizzo, il prodotto deve essere destinato al recupero secondo i canali ordinari di smaltimento.

Legal provisions/Disposizioni di legge

These instructions comply with Legislative Decree 206/2005, "Consumer Code" and with the European directives 85/374 / EEC, 1999/34 / EC and 1999/44 / EC.

Queste istruzioni sono conformi al D. lgs. 206/2005, "Codice del consumo" e con le direttive Europee 85/374/CEE, 1999/34/CE e 1999/44/CE.

Care and maintenance/Cura e manutenzione

Clean the wooden parts with a very soft and dry cloth. In case of persistent dirt or stains, use small quantities of neutral soap, diluted in water (eg 2% soap 98% water) and then dry with a soft, dry cloth. To remove stains, never rub the surfaces with pressure. Never use products containing alcohol or ammonia. Avoid prolonged contact with any type of liquid and do not place the furniture near heat sources. For cleaning fabrics, in addition to normal suction, it is recommended to apply a specific product once or twice a year. To avoid stains, clean immediately using an absorbent cloth only.

Pulire le parti in legno con un panno molto morbido e asciutto. In caso di sporco persistente di macchie, utilizzare piccole quantità di sapone neutro, diluito in acqua (ad es. 2% di sapone 98% di acqua) e quindi asciugare con un panno morbido e asciutto. Per rimuovere le macchie non strofinare mai le superfici esercitando pressione. Non utilizzare mai prodotti contenenti alcol o ammoniaca. Evitare il contatto prolungato con qualsiasi tipo di liquido e non posizionare gli arredi vicino a fonti di calore. Per la pulizia dei tessuti, oltre alla normale aspirazione, si raccomanda di applicare una o due volte all'anno un prodotto specifico. Per evitare macchie, pulire immediatamente utilizzando solamente un panno assorbente.

Passoni Luigi Sedie Srl – Passoni Design
refuse any responsibility for damages caused to persons or things deriving from an improper use of the product.

Passoni Luigi Sedie Srl – Passoni Design declina qualsiasi responsabilità per danni causati a persone o cose derivanti da un uso improprio del prodotto.