

The background is a complex, abstract composition of black and white geometric shapes. On the left side, there are several thick, parallel black stripes that appear to be part of a larger, tilted structure. On the right side, there are vertical black bars of varying heights and widths, some of which are slightly offset from each other, creating a sense of depth and perspective. The overall effect is that of a stylized, architectural or industrial environment.

**driade**



1968

# laboratorio estetico



Fondata nel 1968, Driade ha raggiunto immediatamente un posizionamento estremamente riconoscibile nella fascia più esclusiva del mercato del design. La reputazione di Driade è inevitabilmente legata a grandi designer e personalità della cultura, autori di icone: Philippe Starck, Ron Arad, Fabio Novembre, Patricia Urquiola, Rodolfo Dordoni, Konstantin Grcic, Antonia Astori, Enzo Mari, Alessandro Mendini, Borek Sipek, per citarne alcuni. Una collezione che copre l'intera abitazione, da oggetti d'arte a strumenti per l'utilizzo quotidiano, oltre ad arredi per abitazioni uniche nel loro genere, giardini meravigliosi, uffici non convenzionali e spazi pubblici spettacolari. Da quella stagione in cui il design ha determinato una nuova corrente di pensiero, funzione ed immagine, Driade ne è uno dei grandi oratori, capace di coniare in anticipo una koiné compresa a tutte le latitudini proprio in quanto scritta da lingue e linguaggi diversi. Se fosse una città sarebbe New York o Londra o la Roma vissuta dal Caravaggio o più semplicemente la Milano della Famiglia Astori. Oggi abita in tante città, nelle dimore più esclusive o in quelle più stylish, provocando quel sinuoso equilibrio tra coerenza e cambiamento, tra rottura e cultura, seguendo quel mito della progettazione che va "dal cucchiaio alla città", in una collezione divenuta lifestyle.

Dopo cinque decenni Driade rimane coerente, rieditando il logo del 1968 assieme ad una capsule di sedute-icona tra le quali Costes, Nemo e una speciale limited edition in 50 pezzi: Miss Lacy. Lusso da intenditori. Con tale filosofia e joie de vivre, Driade rappresenta un mix eclettico pronto a sorprendere. Ecco perché Driade è LABORATORIO ESTETICO!

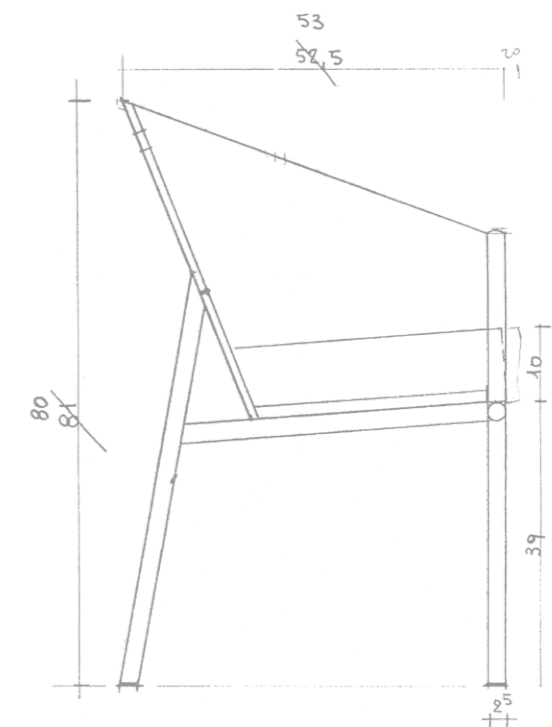

“Che senso ha il nostro lavoro se non possiamo continuamente sperimentare?”

ENRICO ASTORI  
Fondatore di Driade

Founded in 1968, Driade quickly gained a well-recognised positioning in the High Luxury segment of the branded design furniture market. Driade's reputation is linked to eminent designers and cultural personalities, authors of many icons: Philippe Starck, Ron Arad, Fabio Novembre, Patricia Urquiola, Rodolfo Dordoni, Konstantin Grcic, Antonia Astori, Enzo Mari, Alessandro Mendini, Borek Sipek among others. The collection covers the whole home and ranges from objects of art to daily use tools, furniture for one of a kind houses, marvelous gardens, smart office and flamboyant public spaces. From a season in which design determined a new trend in terms of mindset, function and image, Driade was one of the greatest representatives, being the first to invent a koiné that is understood at any latitude because written in different languages and codes. If it were a city, it would be New York, London or even Rome at the time of Caravaggio, or more simply the Milano of the Astori Family.

It now lives in many cities, in the most exclusive or stylish abodes, giving rise to a sinuous balance between coherence and change, break and culture, following the myth of design that goes "from the spoon to the town", in a collection that has become lifestyle.

After five decades Driade remains consistent, re-editing the 1968 logo together with a capsule collection of icon-chairs including Costes, Nemo and a special limited edition in 50 pieces: Miss Lacy. True luxury. Following this philosophy and joie de vivre, Driade is an eclectic mix made to astonish.

That's why Driade is LABORATORIO ESTETICO!

“There is no point to work without experimentation!”

ENRICO ASTORI  
Driade founder

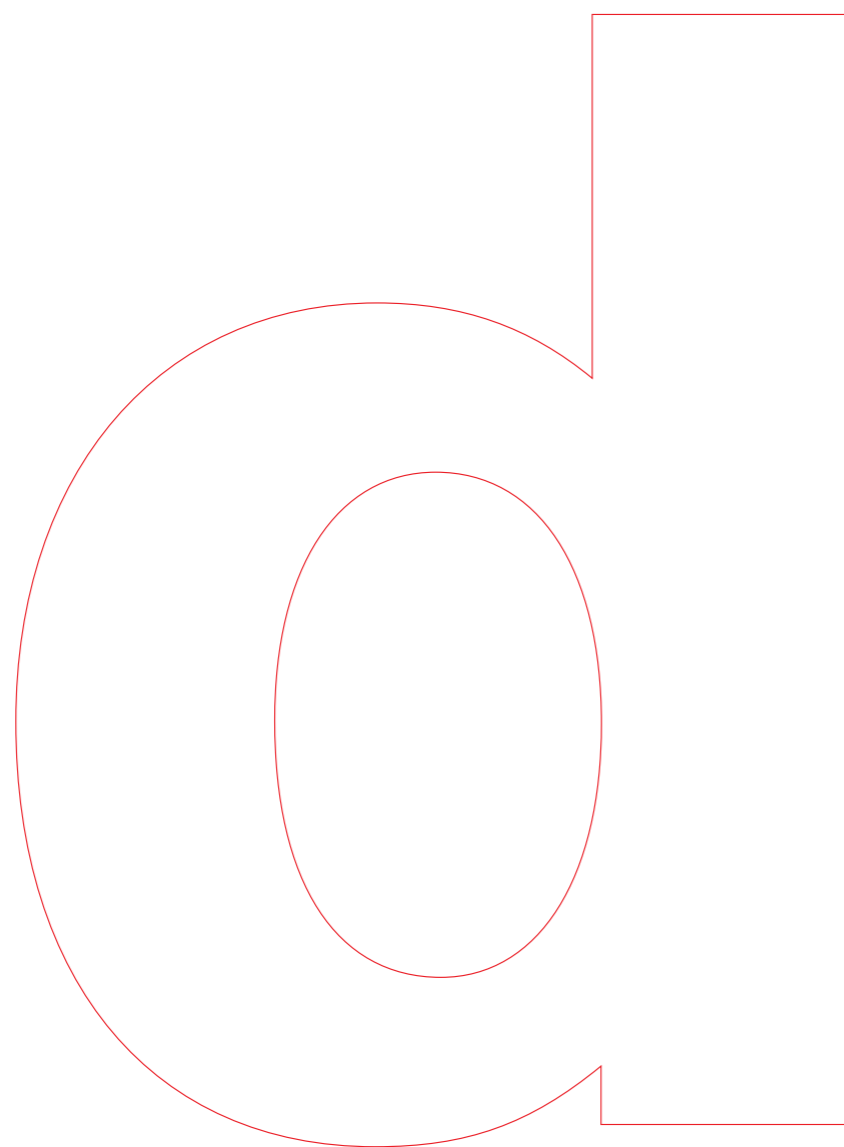

## designers

Alberto Lievore  
Antonia Astori  
Antonio Rodriguez  
Borek Sipek  
Carlo Colombo  
Christophe Pillet  
Dai Sugasawa  
DriadeLab  
Ed Annink  
Elliott Littman  
Enzo Mari  
Eugeni Quitllet  
Fabio Bortolani  
Fabio Novembre  
Faye Toogood  
Francesco Bolis  
Francesco Librizzi  
Fredrikson Stallard  
Front  
Gabriele e Oscar Buratti  
Giuseppe Chigiotti  
Gordon Guillaumier  
Italo Rota  
Jeannette Altherr  
Kazuyo Sejima  
Konstantin Grcic  
Linde Burkhardt  
Ludovica + Roberto Palomba  
Manel Molina  
Marco Romanelli  
Marta Laudani  
Matteo Thun  
Miki Astori  
Nanda Vigo  
Naoto Fukasawa  
Paolo Rizzatto  
Park Associati  
Patricia Urquiola  
Philippe Nigro  
Philippe Starck  
Pietro Derossi  
Rodolfo Dordoni  
Ron Arad  
Stefano Maffei  
Tokujin Yoshioka  
Toyo Ito  
Vittorio Locatelli  
Walter Becchelli  
William Bertocco  
Xavier Lust

<b>Laboratorio estetico</b>	2
<b>Sedie</b> <b>Chairs</b>	8
<b>Tavoli e tavolini</b> <b>Tables and coffee tables</b>	60
<b>Contenitori e librerie</b> <b>Cabinets and bookcases</b>	138
<b>Complementi d'arredo</b> <b>Furnishing accessories</b>	162
<b>Poltrone e divani</b> <b>Armchairs and sofas</b>	202
<b>Letti</b> <b>Beds</b>	300
<b>Outdoor</b>	308
<b>Index</b>	377



What's inside

SEDIE

---

# chairs

---

Una collezione di sedute, tutte diverse l'una dall'altra. Ciascuna con la propria personalità.  
Una collezione ricca ed eclettica quella di Driade; sedie di design, poltroncine, pouf e sgabelli  
sapientemente realizzati in legno, cuoio, metallo, midollino o materiali plastici  
a testimoniare l'amore per la ricerca e la sperimentazione  
che da sempre contraddistingue l'operato del marchio.

A collection of chairs, all different; each with its own personality.  
An eclectic collection, the one by Driade; chairs, easychairs, pouf and stools,  
skillfully realized in wood, leather, metal, rattan and plastic materials  
to testify driade passion for research and experimentation.





## costes

DESIGN \_ PHILIPPE STARCK



Esistono oggetti che vengono universalmente riconosciuti come icone.

La poltroncina Costes disegnata da Philippe Starck nel 1984 per l'omonimo caffè parigino deve il suo intramontabile successo all'assolutezza della forma: una scocca in legno avvolgente e tre gambe fortemente inclinate.

There are objects universally recognized as icons. Costes easy chair designed by Philippe Starck for the homonymous Parisian café, owes its timeless success to the absoluteness of forms: a wooden embracing structure with three highly tilted legs.



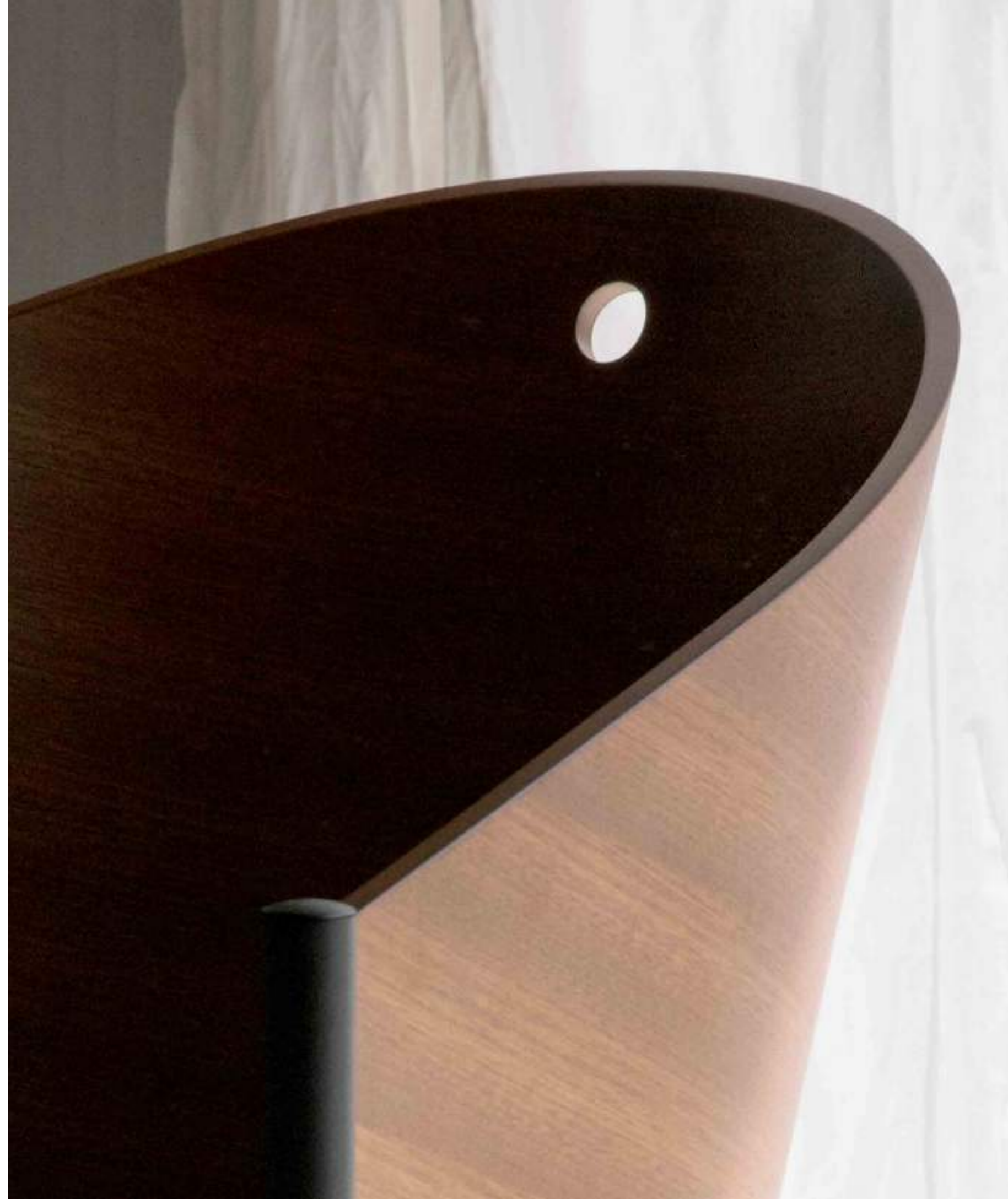





## king costes

DESIGN \_ PHILIPPE STARCK



Reinterpretazione della poltroncina Costes, King Costes ne modifica le dimensioni e la staticità, confermando l'assoluta riconoscibilità dell'immagine e la capacità di alcuni prodotti di durare nel tempo prescindendo dall'alternarsi delle mode.

As a reinterpretation of Costes chair, King Costes alters its size and increases its firmness while confirming the absolute recognition of this image and its durability against trends alternation.

## la francesa

DESIGN \_ LIEVORE ALTHERR MOLINA

La Francesa è una seduta elegante che si integra facilmente in qualsiasi tipo di ambiente. Le gambe, realizzate in frassino ebanizzato o in frassino naturale, sorreggono una scocca confortevole e avvolgente.

La Francesa is a refined seat that easily blends into any setting. The legs made of ebonised european ash or natural ash support the high comfort cozy body.







## **lou eat**

DESIGN \_ PHILIPPE STARCK WITH D. SUGASAWA



Poltroncina rivestita in pelle o tessuto.  
È pensata come seduta per la sala  
da pranzo ma è perfetta anche  
come singola protagonista degli spazi.

Small armchair upholstered in leather or fabric.  
Conceived as a dining room seat,  
it is also ideal as the sole protagonist of spaces.





“Lou Eat is not a chair,  
it is an animal-like sculpture  
that could eat you.”

PHILIPPE STARCK



## miss lacy 50 Limited Edition

DESIGN \_ PHILIPPE STARCK

Pizzo e tacco 12 con finitura rame: la Miss Lacy in 50 pezzi Limited Edition diventa MacRamé, una lavorazione di grande pregio tecnico e stilistico che strizza l'occhio all'eleganza del pizzo macramé che si posa sensualmente su quattro gambe disegnate come stiletto dal stilista del design francese Philippe Starck.

Lace and high, copper finish, stiletto heels: the 50 Limited Edition pieces of Miss Lacy become MacRamé: workmanship of great technical and stylistic skill reminiscent of the elegance of Macramé lace falls sensually over four legs designed to resemble stiletto heels. By the stylist of French design, Philippe Starck.

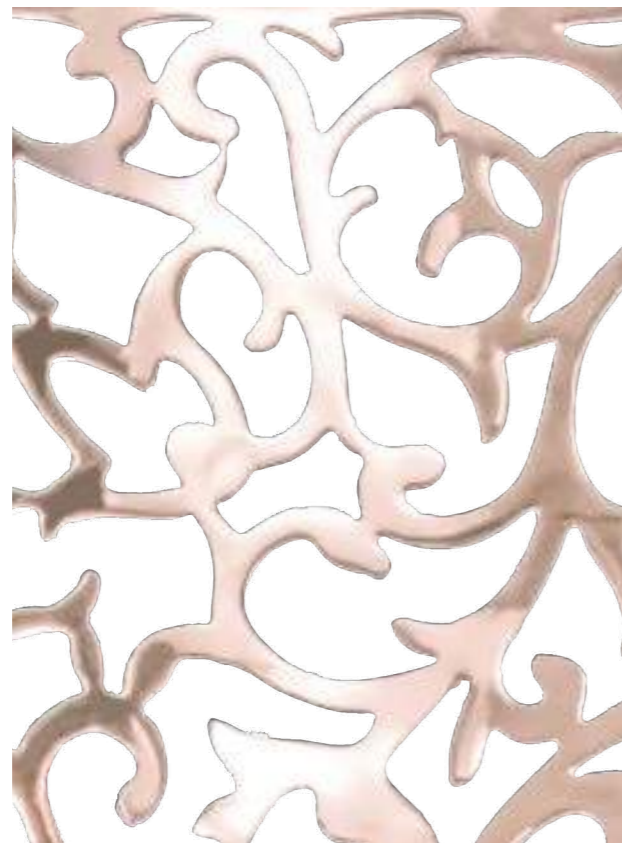



## **miss lacy**

DESIGN \_ PHILIPPE STARCK

Caratterizzata dalla lucentezza dell'acciaio inox sapientemente traforato e finito a specchio, Miss Lacy acquista un'unicità che usualmente caratterizza piuttosto i gioielli che gli oggetti funzionali. È uno dei prodotti più artigianali dell'intera collezione Driade.

Obtained from the ancient lost wax casting technique, Miss Lacy represents and makes accessible a baroque lace by transforming it into an embracing shell. Characterized by the expertly pierced shiny mirrored stainless steel. It is unique that compares more to a jewel than to a functional object.







## soirée

DESIGN \_ OSCAR E GABRIELE BURATTI

Tipologia classica, il tema della sedia morbida e tessile, monomaterica e imbottita, è qui interpretato con particolare eleganza e cura nel disegno. In tessuto o pelle, sempre da gran sera, rivela la sua contemporaneità nelle particolari proporzioni e nella curva del suo schienale; pensata sia per gli spazi privati del dining domestico che per quelli più pubblici della ristorazione e dell'hotellerie. Affida al dettaglio sofisticato della cucitura a contrasto il suo carattere forte e la sua presenza iconica.

The theme of the classic, soft, fabric-covered, padded chair made of a single material is interpreted here in an exceptionally elegant, accurately finished design. Whether dressed in fabric or leather, always ready for a great Soirée, the particular proportions and curve of its backrest reveal its contemporary attitude. This chair is designed both for private dining at home and for public places such as restaurants and hotels. Its strong personality and iconic appeal are conveyed by sophisticated, contrasting stitching.



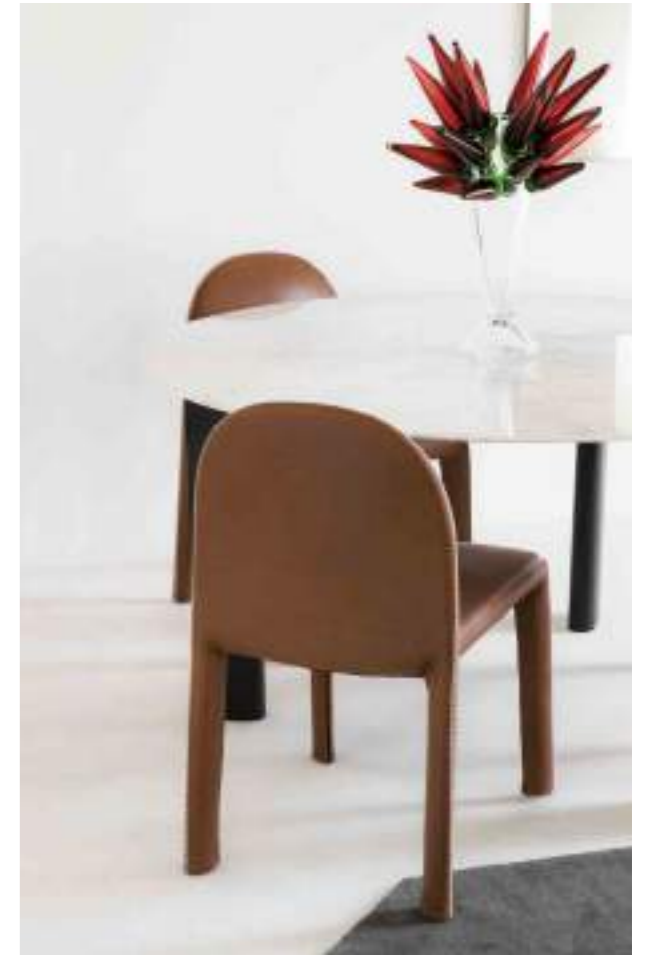



“Chinese design has been  
a great inspiration...  
When I started the concept  
I wanted to create  
a design that really pays homage  
to the culture”

KONSTANTIN GRIC



## mingx

DESIGN \_ KONSTANTIN GRČIČ

Serie di seduta, poltrona, poltroncina e sgabelli caratterizzati dal profilo in tubolare. Seduta in cuoio per l'indoor e con cuscino per l'outdoor. Proposta nei colori bronzo, nero e arancio.

Set of chairs, armchairs, easychairs, and stools characterized by a tubular profile. Leather seat for indoor and cushion seat for outdoor. Colors: orange, bronze and black.







## **meridiana**

DESIGN \_ CHRISTOPHE PILLET

Diamante che si fa seduta,  
Meridiana è realizzata nelle varianti  
sedia, poltroncina e sgabello  
con scocca in policarbonato  
oppure in pelle.

Diamond that becomes seating,  
Meridiana is available  
in the version chair, easychair  
and stool with shell  
in polycarbonate or in leather.



## lagò

DESIGN \_ PHILIPPE STARCK

Caratterizzata dalla forma avvolgente della scocca e delle gambe a "spillo", Lagò viene esaltata dal colore assoluto e brillante che uniforma l'intera superficie. Disponibile anche in cuoio.



Characterized by the embracing shell and "stiletto" legs, Lagò is enhanced by intense and bright colors that smooth the entire surface. Also available in leather.







## liba

DESIGN \_ BOREK SIPEK

Sipek, artista artigiano capace di piegare la materia ai suoi desideri, trova nel rattan e nel midollino una straordinaria potenzialità. Ne discende una vitalità scultorea sospesa tra cubismo e barocco.

Sipek, artist and craftsman able to bend materials to his desires, finds a great potential in rattan and cane. The result is a sculptural vitality suspended between cubism and baroque.





## neoz

DESIGN \_ PHILIPPE STARCK

Neoz sposa la poetica del legno massello e rivisita gli archetipi formali della tradizione.

Ne deriva una collezione "senza tempo", caratterizzata da sezioni vigorose e dalla forza dell'immagine.

A sedia, poltroncina e sgabello si affiancano la serie dei tavoli e dei tavoli bassi, i divani ed il letto.

Neoz embraces the poeme of solid wood and reviews the traditional archetypes. The result is a "timeless" collection characterized by straight lines as well as by a strong image. Chair, armchair and stool go with the series of tables, low tables, sofas and bed.



## sof sof

DESIGN \_ ENZO MARI

Realizzata da Driade nel 1972,  
Sof Sof con le sue linee armoniose  
riassume l'essenzialità e l'eleganza  
del design di Enzo Mari.

Made by Driade in 1972,  
Sof Sof reflects the essential elegance  
of the design by Enzo Mari.





## ed archer

DESIGN \_ PHILIPPE STARCK



"L'abito integrale" in cuoio che giunge a terra contrasta fortemente con l'unica gamba posteriore "a pinna di squalo" in alluminio lucidato. Ed Archer è, senza dubbio alcuno, una sedia scenograficamente protagonista.

The leather "full dress", that reaches the floor, strongly opposes to the only polished casting aluminium "shark finned" back leg. Ed Archer is undoubtedly a scenographic protagonist.



“In a room for the well-being many elements called “furniture” are necessary that actually once set remain “fixed”. I always reject the tendency to overload the space; therefore I have always worked to the limit of need”.

NANDA VIGO

## blocco

DESIGN \_ NANDA VIGO



La seduta Blocco nata con questo intento nel 1970 viene ora riproposta con la stessa funzione ma con un maggiore spirito di allegria nella scelta dei rivestimenti. Buona seduta!

The seat Blocco born with this aim in 1970 is now re-edit with the same function but with a greater spirit of joy in the choice of covers. Good seat!



TAVOLI E TAVOLINI

---

# tables, coffee tables

---

Tavoli, ma anche tavolini da salotto, tavoli bassi, scrittoi.

Basta un piano, ma rispettoso della regola che lo vuole parallelo al suolo,  
mentre le gambe possono sbizzarrirsi a volontà.

Tavoli rettangolari, tavoli rotondi e ovali, quadrati ma anche tavoli dalle forme inedite,  
inaspettate e gioiose; icone della storia del design e nuovi protagonisti.

Tables, but also coffee tables, side tables and desks. It's enough that the top respects  
the rule that wants it parallel to the ground, while the legs can indulge themselves at will.

Rectangular and round tables, squared and ovals, but also table with unexpected  
and joyful shapes: icons of the history of design and new characters.

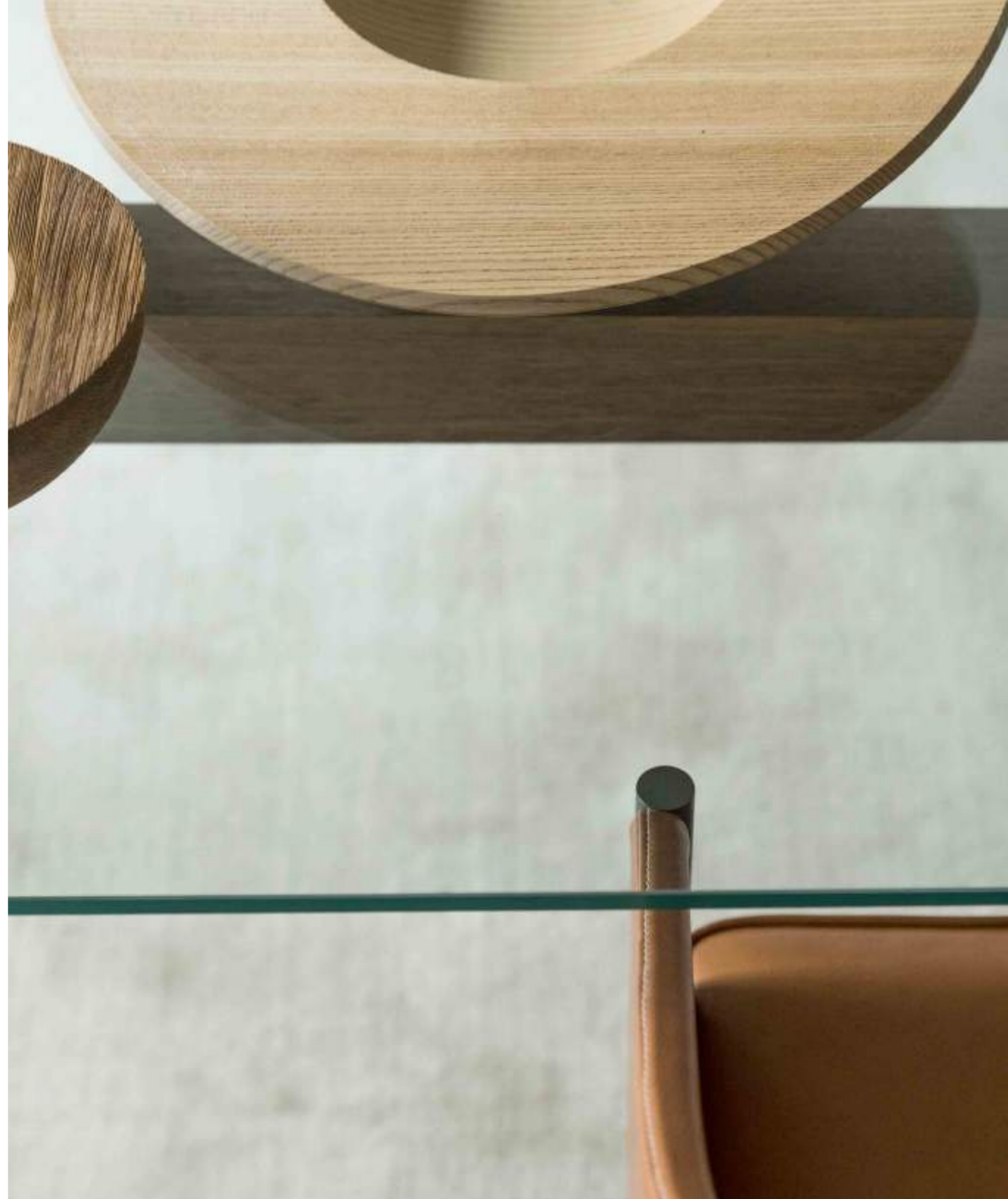





50 years of lifestyle

## frate

DESIGN \_ ENZO MARI

Con la consueta lucidità Enzo Mari decide di procedere, in questa collezione di tavoli, con piani in cristallo trasparente. Solo così sarà possibile valorizzare la scabra essenzialità dei supporti in profilati metallici. Disegnati nel 1973, da allora ininterrottamente in produzione, questi pezzi sono certamente annoverabili tra i più felici del maestro milanese.

Very lucidly, Enzo Mari decided to realize this tables collection with transparent crystal tops in order to valorise the harsh simplicity of steel sections bases. Designed in 1973, uninterruptedly produced since then, these pieces can be certainly numbered among the most successful of the Milan master.





**fratello**

DESIGN \_ ENZO MARI

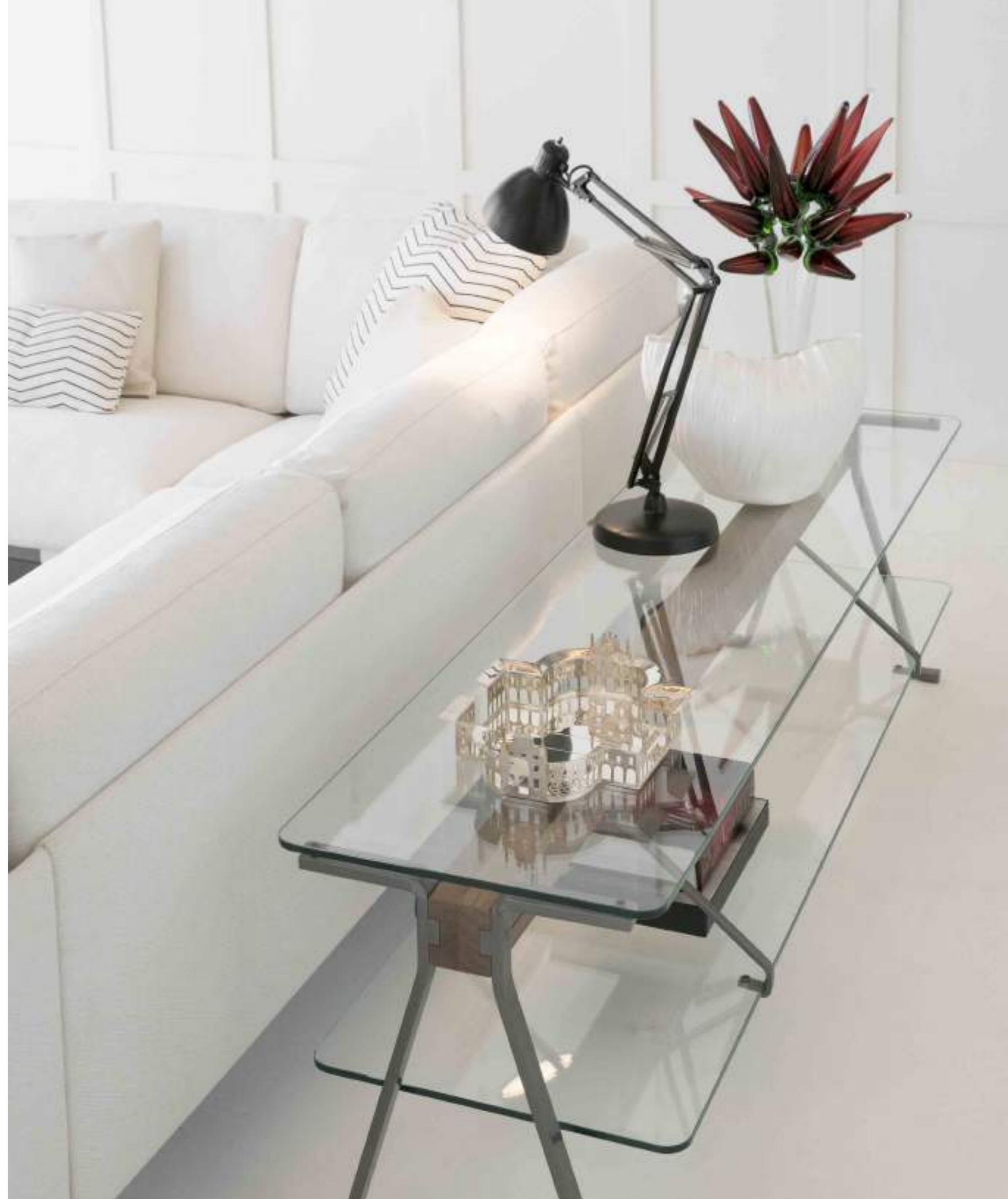

“There is more to a design object  
than its appearance,  
it is everything it represents”.

ENZO MARI





**cugino**

DESIGN \_ ENZO MARI





**cuginetto**  
DESIGN \_ ENZO MARI





## françois

DESIGN \_ LIEVORE ALTHERR

Le gambe asimmetriche incorniciano il piano, che sembra sospeso nel vuoto, valorizzandolo. Gli angoli arrotondati, le forme morbide, l'estrema piacevolezza nel tatto rendono François un oggetto da amare nel vivere quotidiano.

The asymmetrical legs enhance the tabletop, making it look as if it is floating in mid-air. Its rounded corners, soft forms and extremely pleasant feel make it an object to fall in love with every day of the year.







## fourdrops

DESIGN \_ OSCAR E GABRIELE BURATTI



Il rapporto tra elemento verticale portante, la gamba con sezione a goccia che dà il nome al progetto, e l'elemento orizzontale portato - il piano dalla sezione rastremata e arrotondato sugli angoli - costituisce un sistema di tavoli lussuosi nei materiali e puri nelle forme. Il sistema gamba/piano prevede diverse forme di tavolo, rettangolare e tondo. Da esaltare in spazi dalle dimensioni importanti, non solo grazie alle dimensioni ma anche grazie alla palette materica dove i legni naturali e laccati, i marmi venati e il vetro retroverniciato in vari colori, ne consentono diverse interpretazioni. Un progetto di architettura alla scala del design, dove essenza della forma e ricchezza del dettaglio costituiscono gli estremi di un processo creativo dei fratelli del design milanese, Oscar e Gabriele Buratti.

The relationship between the vertical support - the drop-section leg from which the project takes its name - and the horizontal top with tapered edges and round corners - forms an occasional table system featuring luxurious materials and pure lines. This leg/top system produces various rectangular or round table shapes which are best enhanced in large spaces. This is not merely due to their size but also thanks to the many materials available, including natural and lacquered wood, veined marble and glass lacquered on the reverse side in many colours, which inspire various interpretations. Minimalist shapes and rich details are the extremes of a creative process by Oscar and Gabriele Buratti, an architectural project scaled down to suit design. white carrara or nero marquina marble tops.









## easel

DESIGN \_ LUDOVICA + ROBERTO PALOMBA

Easel è un tavolo che gioca sulle proporzioni e la dinamicità. Disponibile in tre diverse lunghezze (220, 240 e 270cm), con struttura in massello di noce canaletto o in massello di frassino ebanizzato, ben si presta ad essere inserito in ogni ambiente, dal classico al contemporaneo. Elegante elemento d'arredo, ha un aspetto aereo e trasparente.

Easel is a table that plays on proportions and dynamism. Available in three different lengths (220, 240 and 270 cm), with a structure in canaletto walnut or solid ebonized ash wood, this table is perfect for any room, from classic to contemporary styles. This elegant piece of furniture has a transparent, airy look.



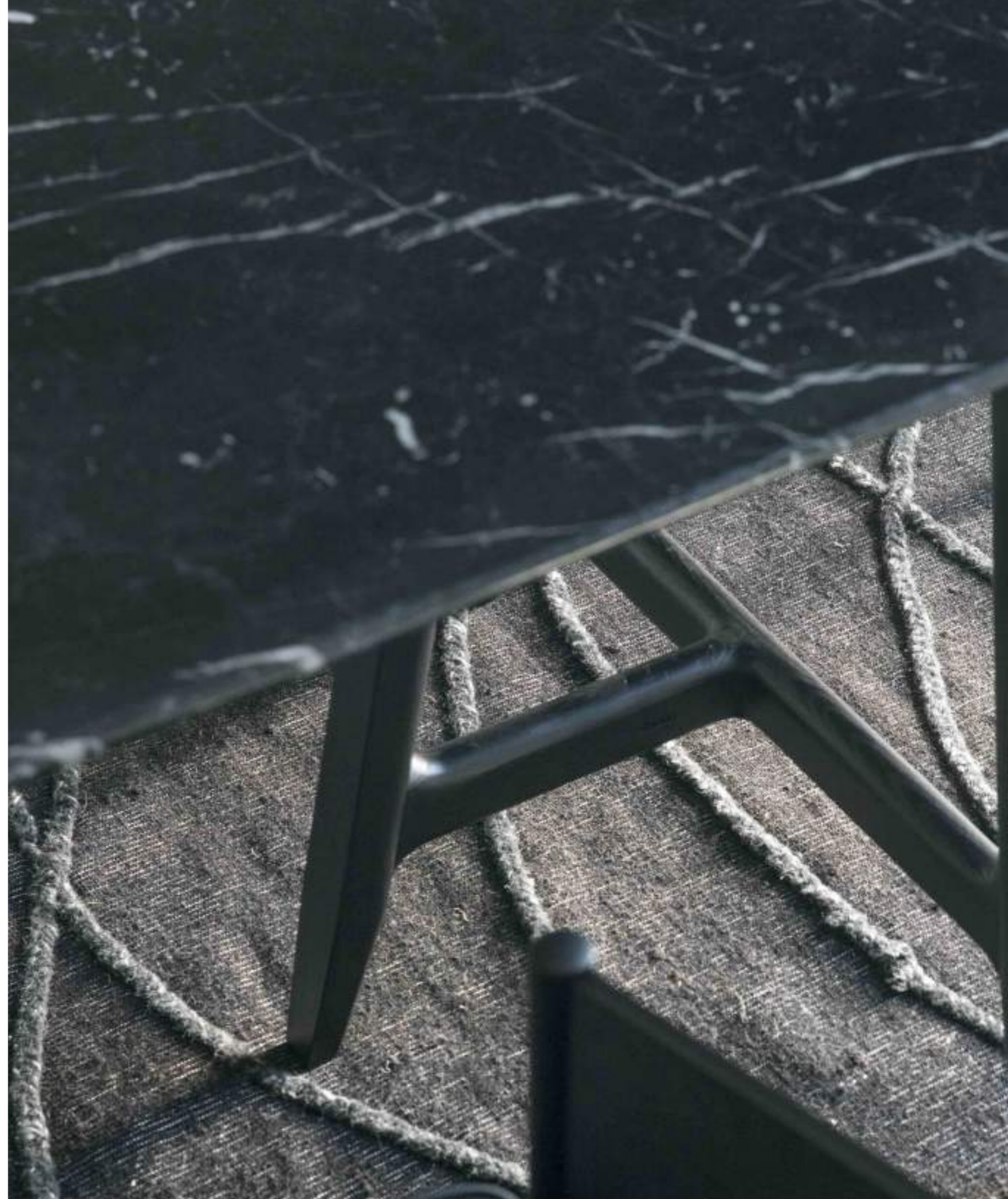



## **anapo**

DESIGN \_ GORDON GUILLAUMIER

Il piano del tavolo Anapo, è retto da una base scultorea in acciaio verniciato nero. Una sequenza di tubi metallici che dona tensione allo spazio, con un raffinato effetto di semitrasparenza. Ispirazioni anni sessanta, per una certa idea di casa borghese tesa tra rigore e morbidezza, tra lusso e funzionalità.

The Anapo table top is supported by a sculptural base in black painted steel, a sequence of metal tubes that gives tension to the space, with a refined semi-transparent effect. Its inspiration lies in the sixties and in a specific idea of conventional home torn between rigor and softness, between luxury and functionality, indifferent to passing fads. The project also includes three coffee tables.







## didymos

DESIGN \_ ANTONIA ASTORI

Il tavolo ovale e il tavolo rotondo sono tavoli perfetti: nessuno spigolo, nessun capotavola, nessun commensale "dispari" e soprattutto una forma straordinaria nello spazio.

In a table, oval and rounded mean perfect: no edge, no head of the table, no "odd" diner and, above all, a form expanded in space.







## mingx

DESIGN \_ KONSTANTIN GRČIČ

I tavoli della collezione Mingx si distinguono per la caratteristica struttura dal profilo tubolare. I piani sono disponibili in noce canaletto, in metallo o in quarzite.

The tables with American walnut top and tubular steel frame are proposed in the cantilevered or flush version, like the writing desk and the low table.



## gazelle

DESIGN \_ PARK ASSOCIATI

Un tavolo che gioca sul disequilibrio apparente, sostenendo un piano fortemente materico, su una sequenza di tre strutture posizionate in maniera del tutto imprevedibile.

A table that plays on an apparent imbalance, supporting a strongly materic top, by a sequence of three structures placed in a totally unpredictable way.





## meridiana

DESIGN \_ CHRISTOPHE PILLET

Dalla sedia globetrotter per eccellenza, rivisitata quest'anno con gambe in legno massello, nasce il tavolo Meridiana. Archetipo del tavolino da caffè o domestico, si presenta con un prezioso equilibrio tra il piano (rotondo) di particelle di legno e la struttura con gambe in legno massello. Rasatura a mano con spatola di un composto a base di argilla colorata in massa. Le sfumature dell'applicazione manuale caratterizzano l'estetica del prodotto. Nei colori: rosso vulcano, pece e champagne.

The Meridiana table stems from the ultimate globetrotter chair, revised this year with solid wooden legs. An archetype of the coffee shop or domestic table, it displays a precious balance between the round, wood particleboard top and the solid wood frame and legs. A mass-coloured clay mixture is smoothed over the top by hand with a scraper. The table's aesthetic is distinguished by the shaded, handmade finish of its top. Available in the following colours: volcano red, lava black and champagne.





## neoz

DESIGN \_ PHILIPPE STARCK

Collezione unica e senza tempo in cui il legno massello si unisce al candore del marmo bianco Carrara e le ruote in nylon fanno da contrappunto alla moltiplicazione delle gambe.

Unique and timeless collection. Carrara white marble combines with ebonized solid wood, while nylon wheels are counter balanced by legs multiplication.







## lybra

DESIGN \_ ELLIOTT LITTMAN

I tavoli, per un designer, sono una tipologia sospesa tra l'architettura e la scultura.

Littman, nel tavolo Lybra, visualizza questa tesi enfatizzando la trave portante in acciaio, rendendola visibile attraverso la trasparenza del piano e conferendole il valore di un'opera.

Tables, for a designer, are somehow suspended between architecture and sculpture.

Littman visualizes this suspension in the Lybra project, by emphasizing the steel supporting beam, making it evident through the top transparency and giving it the value of a craftwork.



“We sometimes have a very bad opinion of the cro-magnons, of their neanderthal friends and of the flintstone family. Luckily, they were far more sophisticated than we can imagine.”

PHILIPPE STARCK

## torquemada

DESIGN \_ PHILIPPE STARCK

Tavolo completamente realizzato in legno massello di Rovere Slavonia verniciato opaco naturale con superficie interamente spazzolata.

Elemento di unione delle gambe e della traversa centrale in piatto alluminio lucidato a specchio.

Table in solid Sessile oak natural matt lacquered with totally brushed top. Binding element of the legs and central beam in polished stainless steel with mirror finish.



## koishi

DESIGN \_ NAOTO FUKASAWA



Dovessimo cercare un simbolo che racconti l'arte zen dei giardini giapponesi, probabilmente sceglieremmo un sasso (in giapponese "ishi"). Naoto Fukasawa partendo da un semplice ciottolo sviluppa un grande pouf.

If we should look for a symbol representing the Japanese gardens art, we would probably choose a stone (in Japanese "ishi"). Naoto Fukasawa develops a big pouf precisely by a small stone.





## sereno

DESIGN \_ FREDRIKSON STALLARD

Tavolo basso supportato da sculture in fusione di alluminio lucidato.

Finitura realizzata mediante sputtering nei colori titanio nero o oro.

Coffee table with sculptures in cast aluminium with metallic finishing made by sputtering technology in black titanium and gold colors.



## carmina

DESIGN \_ LUDOVICA + ROBERTO PALOMBA

Collezione di piccoli coffee tables  
ove la gamba, vezzosamente  
lievitando verso i bordi del top,  
si trasforma in un ricciolo.  
Tecnicamente non è che un  
oggetto, dall'estetica quasi  
brutalista in lamiera verniciata  
ma il colore e questo dolce gesto  
di poesia, lo trasformano in una  
presenza che invita alla quiete  
e al sogno.

Collection of small coffee tables  
with a leg that daintily curls above  
the edge of the top. technically  
speaking it is just an object -  
and quite a plain one at that -  
made of lacquered metal,  
but the use of colour and this  
charming poetical gesture  
transform it into a piece  
that fosters peace and stimulates  
the imagination.





## **basalt**

DESIGN \_ FREDRIKSON STALLARD

Tavolino scultoreo e prezioso. Un frammento materico sostenuto da un supporto museale. Piano in cemento alleggerito con finitura a cera di colore grigio ardesia e struttura in trafilato d'acciaio con finitura oro lucido

Scultural and precious small table. A fragmented piece hold up by a museum stand. Top in lightened concrete with wax finish late-gray color. Structure in drawn steel with polished gold finish.

## ci

DESIGN \_ NAOTO FUKASAWA



Ci (superficie terrestre in giapponese).  
Assieme alla poltrona Ten, avvolgente  
e confortevole, forma una zona lounge  
che si adatta armoniosamente ad ogni  
ambiente, dal classico al metropolitano.

Ci (earth surface in japanese).  
With the Ten armchair, which is cozy  
and comfortable, creates a lounge area  
that harmoniously blends into all interiors,  
from classical to metropolitan.





**zagazig**  
DESIGN \_ DRIADELAB



Una collezione di tavoli bassi, pensati in set di due, in diverse misure che, con libertà, possono vivere singolarmente al centro di un living o ad affiancare le sedute. Le forme sono irregolari e movimentate, giocano su tre altezze e dimensioni diverse. Proprio come in Ziqqurat per ogni top sono previsti due pattern, realizzati in bi-laminato con grafica in stampa digitale, di gusto contemporaneo e molto precisi nella loro riconoscibilità: collage retrò, decori optical, texture che interpretano le trame suggerite dalla creatività della moda d'oggi. La struttura è realizzata in tondino d'acciaio verniciato in color oro. Questa scelta nostalgica, eppure così attuale, dona eleganza e preziosità all'insieme.

A collection of coffee tables in various sizes created as a set of two which can stand by themselves in the centre of the living room or be used as side tables, as desired. Their shapes are irregular and dynamic, available in three different heights and sizes. Just like the Ziqqurat cabinet, each top comes in two different patterns made of digital printed bilaminated with contemporary, very distinctive, designs: vintage collages, optical decors, textures that interpret the weaves suggested by the creativity of current trends. The frame is in gold-coloured tubular steel. This nostalgic yet trendy choice adds elegance and charm to these pieces.



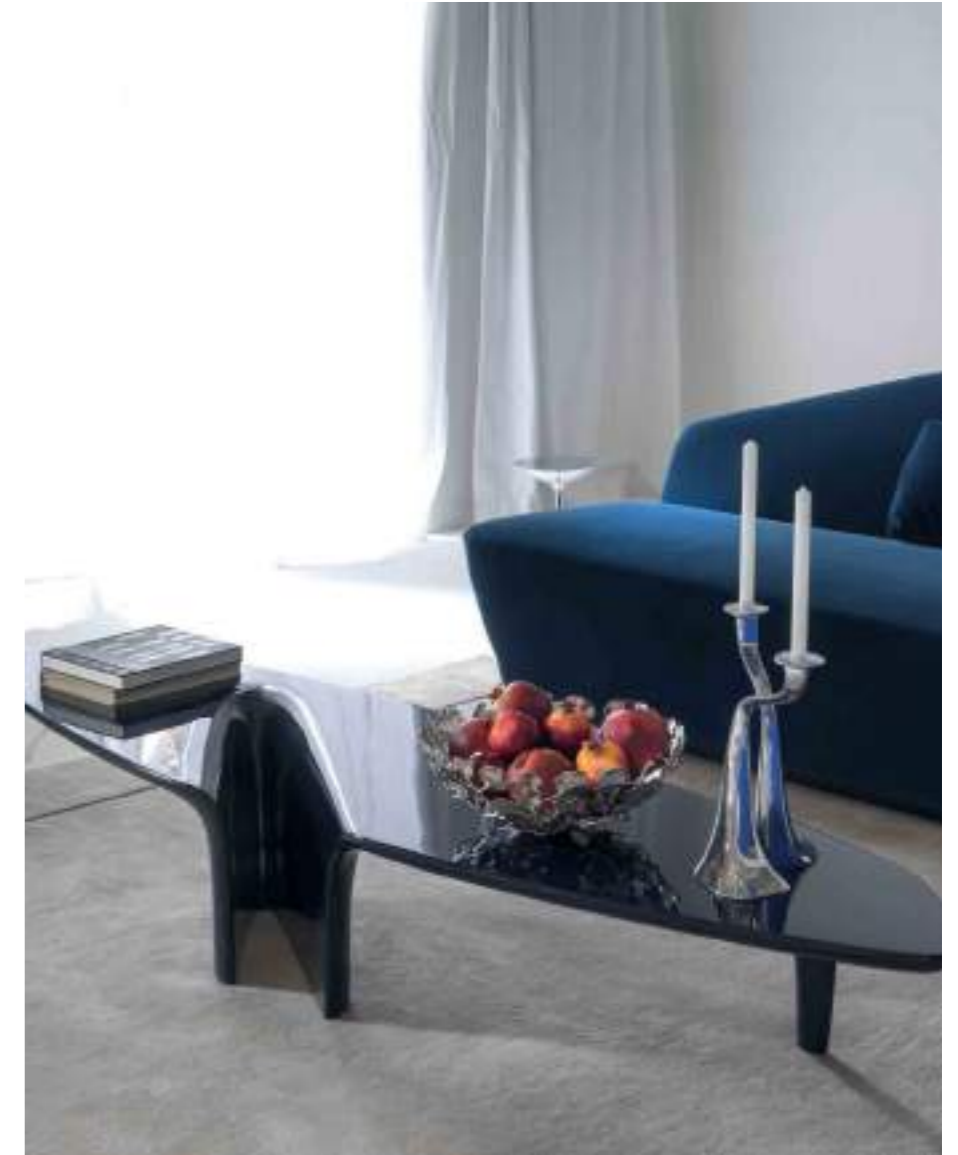

## waterfall

DESIGN \_ FREDRIKSON STALLARD

Un coffee table può diventare un'opera qualora si riesca a prescindere dalle limitazioni tipologiche. Ne risulta una forma del tutto inedita, segnata da un importante, ed espressionistico, incavo al centro del piano.

Even a coffee table can become a piece of art if it can stand regardless of the typological limitations. The result is a completely new form, marked by an important, and expressionistic, depression in the center of the top.



## portable atelier

DESIGN \_ PHILIPPE NIGRO



Uno scrittoio leggero, di dimensioni contenute, con un piano a ribalta che accoglie laptop, fogli e cavi. Portapenne e contenitori in legno e metallo a personalizzare lo spazio con diverse forme e colori. Uno sgabello regolabile che segue ovunque lo scrittoio o si muove autonomamente per sedute volanti e dinamiche. Una mensola in legno e metallo, dotata di elementi scorrevoli ideale per arredare tavoli e scrivanie ritagliando ovunque uno spazio raccolto e personale. Sono questi i protagonisti di Portable Atelier.

A small, lightweight desk with a flap top that can hold a laptop, sheets of paper and wires. Pen holders and storage boxes in wood and metal are for personalising the space with different shapes and colours. An adjustable stool goes everywhere with the desk or can be moved independently for dynamic, improvised seating. A shelf made of wood and metal fitted with sliding elements is ideal for furnishing tables and desks to create a defined personal space anywhere. These are the features of Portable Atelier.



## still life

DESIGN \_ FRANCESCO LIBRIZZI

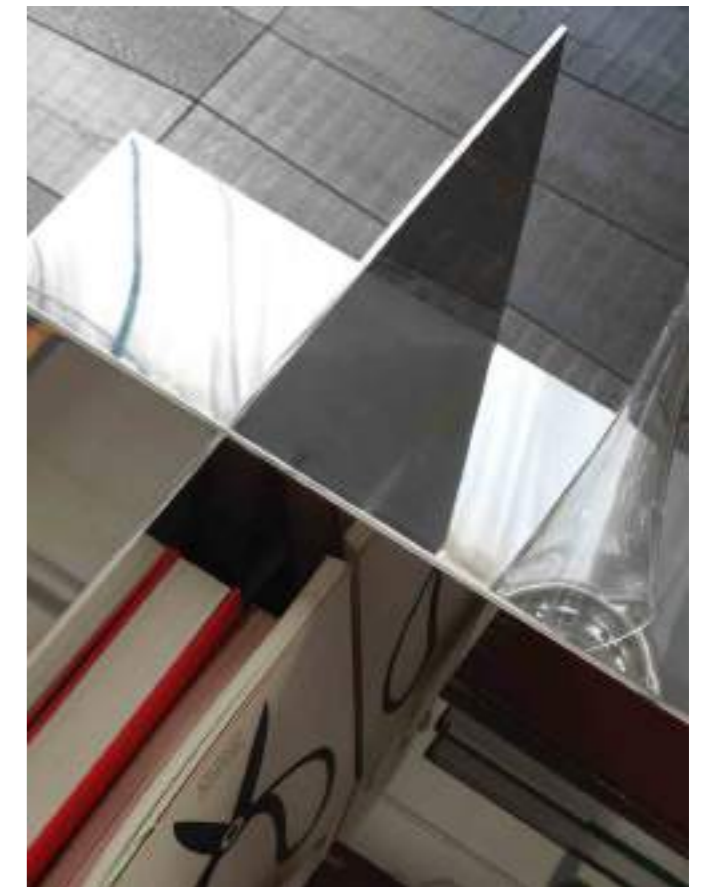

Tipologicamente Still Life è una piccola libreria a torre quadrata. La sua forma consente di poggiare libri e dischi in verticale. Ma i suoi scomparti sono delle quinte teatrali, in grado di isolare e creare uno sfondo ai singoli oggetti che ospitano. Gli oggetti quindi trovano il proprio posto nello spazio, ma oltre ad essere "contenuti", sono "esposti", messi in scena. Still Life è quindi una serie di spazi, una sequenza di scenografie.

Typologically, Still Life is a small, square-shaped bookcase. Its shape allows books and discs to stand vertically on it but its compartments are theatrical wings that separate objects while creating a backdrop for each single one. Things find a place for themselves in a space where they are showcased, staged, as well as contained. Thus, Still Life is a succession of spaces, a sequence of sets.

## psiche

DESIGN \_ PHILIPPE STARCK

Con la sua consueta abilità, sostenuta da una forte capacità di immaginazione, Philippe Starck progetta un tavolo (o uno specchio) che con una semplice rotazione di uno snodo, si trasforma in uno specchio (o in un tavolo), secondo le necessità.

With his usual skill, supported by a strong capacity for imagination, Philippe Starck designs a table (or a mirror) that, with the simple twist of a joint, turns into a mirror (or a table), according to the necessity.





## ping I, II

DESIGN \_ GIUSEPPE CHIGIOTTI

Esistevano un tempo, nelle case, piccoli oggetti servizievoli. Per il fumo piuttosto che per il cucito, per servire piuttosto che per esporre: essi punteggiavano gli spazi dell'abitare. Giuseppe Chigiotti, nell'ideare "Ping", ripensa a quei periodi ormai trascorsi e tratteggia un servante declinato in due versioni: Ping I, caratterizzato dalla dimenticata funzione di svuota tasche, e Ping II, discreto piano d'appoggio per un bicchiere o un libro.

Ancient houses used to be full of many helpful small objects. For putting ashes rather than for sewing, to serve rather than to expose: they punctuated dwelling spaces. Giuseppe Chigiotti, by designing "Ping", thinks back to those times now passed, and creates a "servante" declined in two versions: Ping I, characterized by the function of empty pockets and Ping II, discrete surface for a glass or a book.

## picapica

DESIGN \_ KAZUYO SEJIMA



Dall'ò di Giotto in poi, quanti cerchi! Ma anche prima, risalendo fino all'invenzione della ruota. Il piano del tavolino di Kazuyo Sejima è perfetto e imperativo nella sua semplicità, su quattro esili gambe.

From the o by Giotto onwards, how many circles! But even before that, going back to the invention of the wheel. The table top is perfect and imperative in its simplicity, on four slender legs.





## mak

DESIGN \_ GIUSEPPE CHIGIOTTI

Tavolino su ruote, con quattro ripiani che sporgono dal corpo del tavolino, in modo che possano infilarsi quello più basso sotto il letto e il più alto fungere da appoggio per un servizio di prima colazione.

It's a special trolley with four protruding shelves, the lower of which can crawl under the bed and the upper of which can stand the breakfast or even only a coffee.

CONTENITORI E LIBRERIE

# cabinets and bookcases

Ogni cosa in ordine: è una regola d'oro. Per farlo bisogna organizzarsi e organizzare lo spazio nell'interno dei contenitori, che siano essi mobili contenitore o librerie.

Le librerie Driade sono tutte freestanding, suddividono gli ambienti, arredandoli; pezzi dal design fortemente distintivo, pensati per accogliere libri e oggetti ma bellissimi anche vuoti.

Everything in order: it's the golden rule. To do this we need to organize the space inside the containers, whether they are cabinets and storage furniture or bookcases.

Driade's libraries are freestanding, separate spaces, decorating.

Furniture with an unique design, meant to contain books and objects, beautiful even empty.



## ziqqurat

DESIGN \_ DRIADELAB

# Z

Quale potrebbe essere, oggi, il progetto di un contenitore? Questo il quesito che DriadeLab, osservatorio di Driade sui modi del vivere contemporaneo, si è posto come punto di partenza per la ricerca.

Esito è Ziqqurat, un cabinet che si compone di box differenti i quali, sovrapposti, ne delineano una forma sempre differente. Tale sistema, a tutti gli effetti costruttivo, permette composizioni di tre diverse dimensioni, adattandosi agli spazi dell'abitare.

Non è dunque un caso l'ispirazione all'antica piramide sumera, leitmotiv così forte del progetto tanto da scegliere di citarne anche il nome. Le forme ed i volumi offrono un carattere unico a questo speciale oggetto d'arredo.

What could the design of a storage cabinet be like today?

This is the question DriadeLab, Driade's observatory on contemporary lifestyles, asked itself when it started to research into this project. The result was Ziqqurat: a cabinet made up of different boxes that can be piled up to create everchanging forms. This system, constructive in all respects, can be used to create arrangements of three different sizes depending on the space available. The project's source of inspiration, ancient sumerian pyramids, is no random choice: it is such a strong theme that it even gave its name to the cabinet.

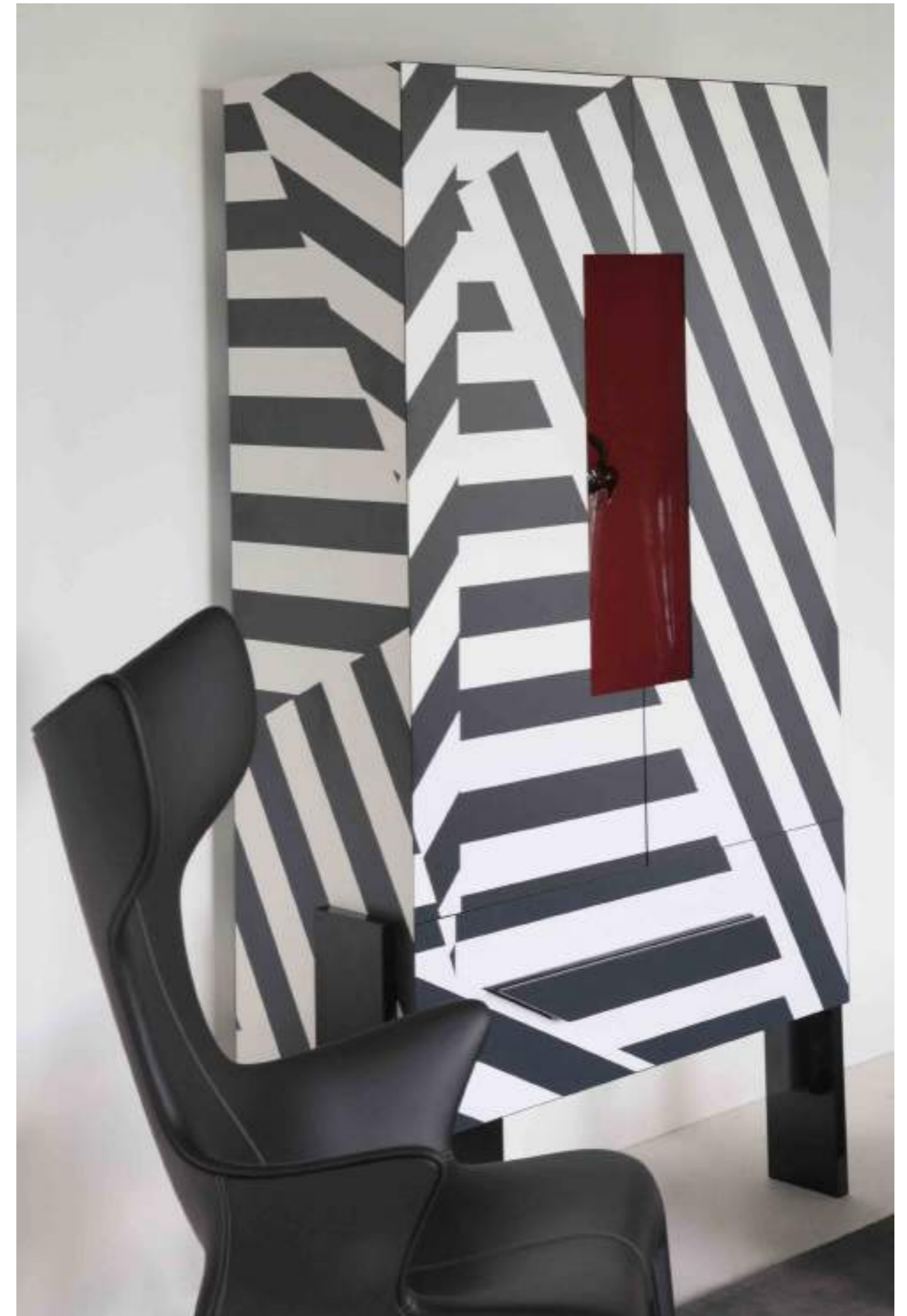
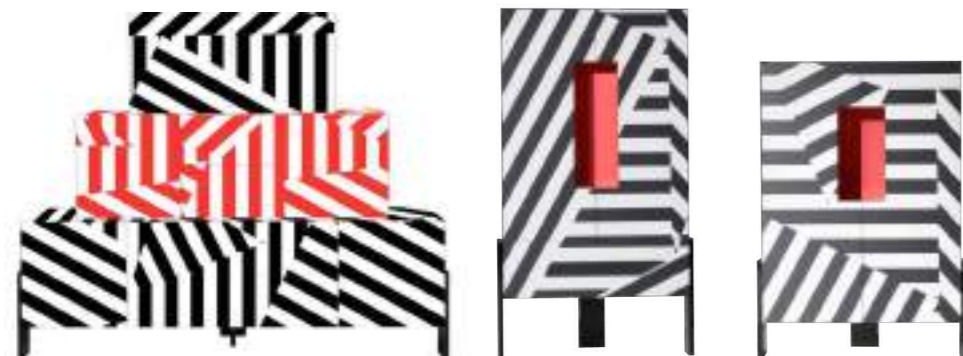











## ercole e afrodite

DESIGN \_ DRIADELAB

Combinazione sorprendente tra arte decorativa e linguaggio storico, questo contenitore dalle forme classiche e scultoree si inserisce come oggetto d'arredo prezioso in un ambiente eclettico e sofisticato.

Unexpected combination of decorative art and historic language, this storage units with its classic sculped shapes becomes a precious furnishing item in an eclectic and sophisticated setting.



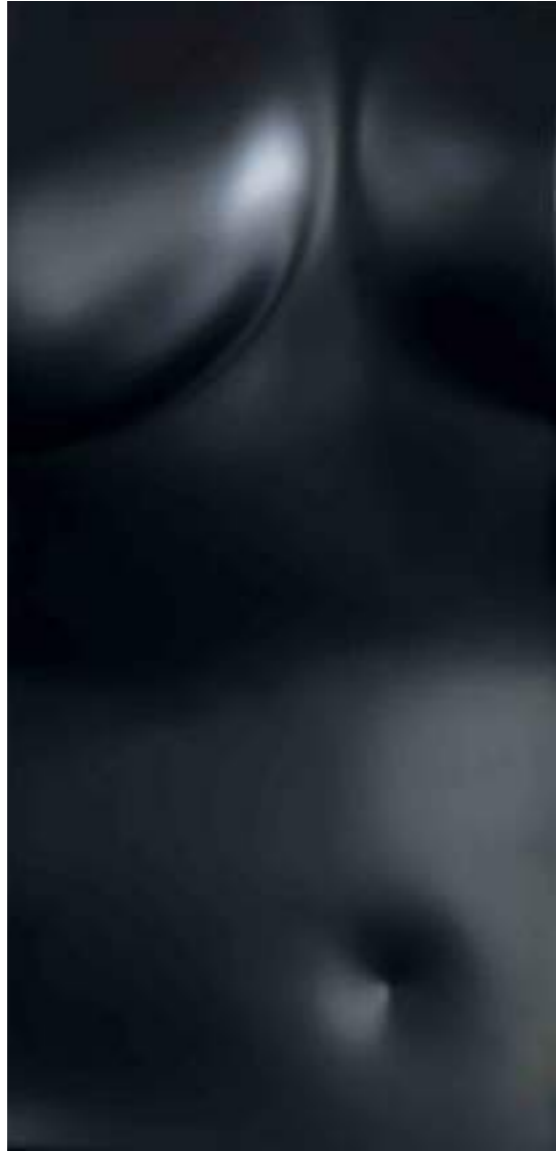



“Canova imagined that his Venus had been caught unawares in the nude and he gave her a marble veil to hide herself from indiscrete eyes. I add a succession of wooden shelves that cross the most private parts of her body to camouflage her in the midst of books and other objects. A four-handed job performed at different moments in time by two italians who are particularly fascinated by the epitome of female beauty: Venus.”

FABIO NOVEMBRE

## venus

DESIGN \_ FABIO NOVEMBRE



Novembre trae ispirazione dalle casse lignee utilizzate dai musei per il trasporto delle statue trasformandole in poetico oggetto di design. La categoria dice che si tratta di una libreria ma uno sguardo differente potrebbe trovare in Venus la statua di una dea. Entrambe le letture sono corrette e si fondono fra loro. Venus è questo: arte, la possibilità di godere della sua bellezza, e funzione, a cui il design mai può sottrarsi.

Novembre draws his inspiration from the wooden crates used by museums to transport statues and transforms them into graceful design objects. It has been classified as a bookcase but a different point of view may regard Venus as the statue of a goddess. Both opinions are correct and interconnected. Venus is both things: art i.e. the possibility of enjoying its beauty, and function, an essential part of design.

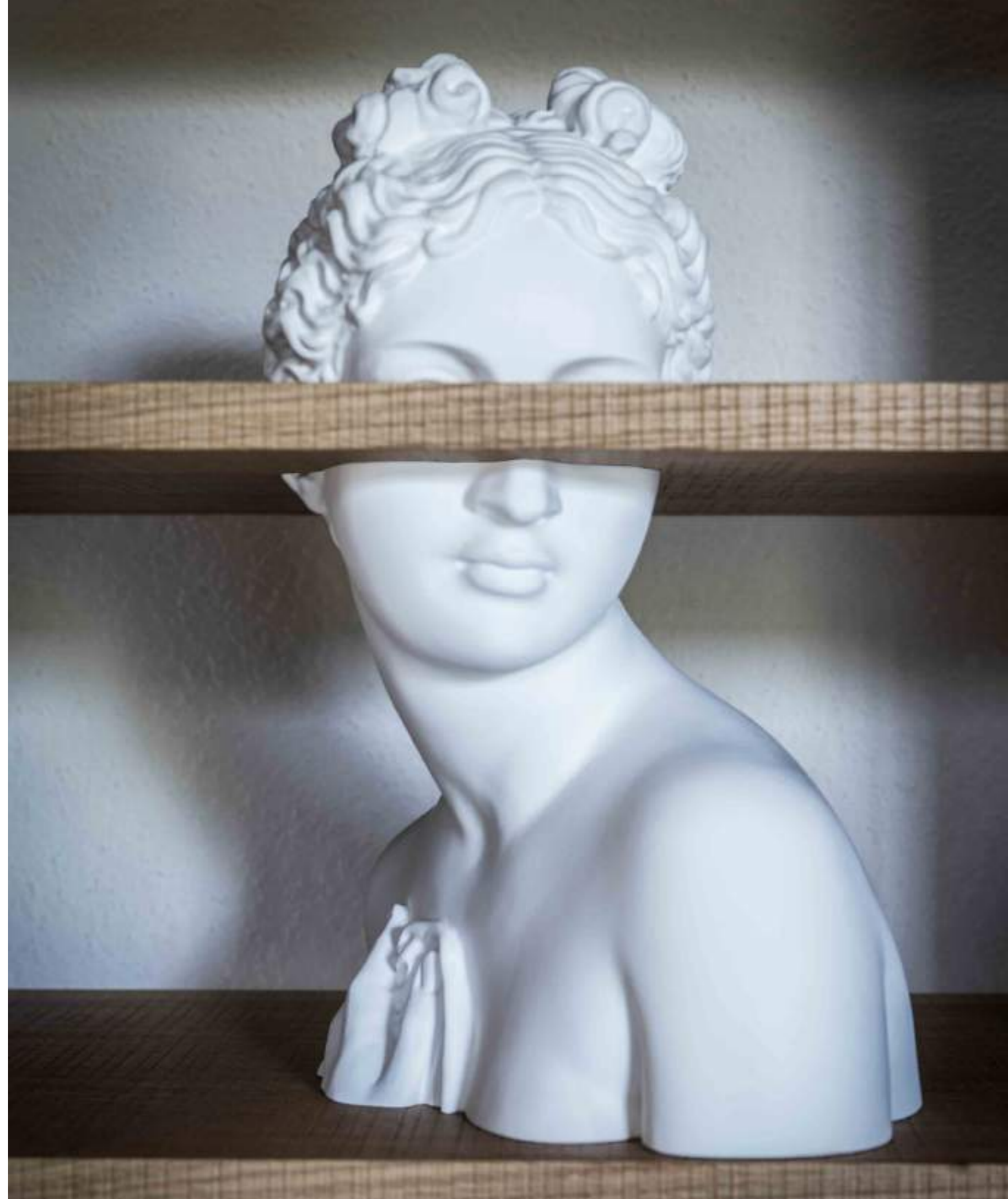



## zigzag

DESIGN \_ KONSTANTIN GRČIČ

La struttura a Zigzag dello scaffale è semplice e fresca; la palette di colori per le parti metalliche - nero, bianco, bronzo e acciaio lucido - è completata da due tipologie di ripiani in legno, in rovere e in noce Canaletto.



The shelf's Zigzag shaped structure is simple and fresh; the color palette for the metal work - black, white, bronze and polished stainless steel - is complemented by two kinds of wooden shelves, oak and Canaletto walnut.







## virgo

DESIGN \_ XAVIER LUST



Virgo è una struttura “in tensione” che prende le sembianze tipologiche di una libreria, ma in realtà ci porta a ragionare sui rapporti tra superfici concave e superfici convesse, sull’energia della corda tesa nell’arco. La forma sculturale assunta da Virgo ne consente l’uso non solo a parete, ma soprattutto al centro dello spazio.

Virgo is a “living” structure which becomes a bookcase but, in fact, leads us to think about concave and convex surfaces relation as about the energy of a tightrope. The sculptural form of Virgo makes it usable both on the wall and, above all, as centre-room.

COMPLEMENTI D'ARREDO

# furnishing accessories

Magia e stupore contraddistinguono i complementi d'arredo Driade:  
lampade evanescenti magicamente sospese, specchi originali,  
tappeti decorativi, paraventi personaggio, appendiabiti poetici.  
Inaspettati complementi d'arredo dal forte carattere in grado  
di personalizzare ogni ambiente.

Magic and surprise are the essence of Driade accessories:  
evanescent lighting magically suspended, original mirrors,  
decorative carpets, screens, poetic coat hangers, unexpected plant holders.  
Furnishing accessories with a strong personality,  
perfect to personalize every ambient.





**nemo miniatura**  
...or simply mini nemo?

DESIGN \_ FABIO NOVEMBRE





## hanahana

DESIGN \_ KAZUYO SEJIMA

La semplicità e la freschezza, tipiche dei progetti di Kazuyo Sejima, sono tutte in questo poetico oggetto: un esile alberello i cui rami salgono al cielo come una preghiera. E con un'offerta di fiori.

The simplicity and freshness typical of the projects by Kazuyo Sejima, are all in this poetic object: a slender tree whose branches rise to heaven like a prayer. And with an offering of flowers.

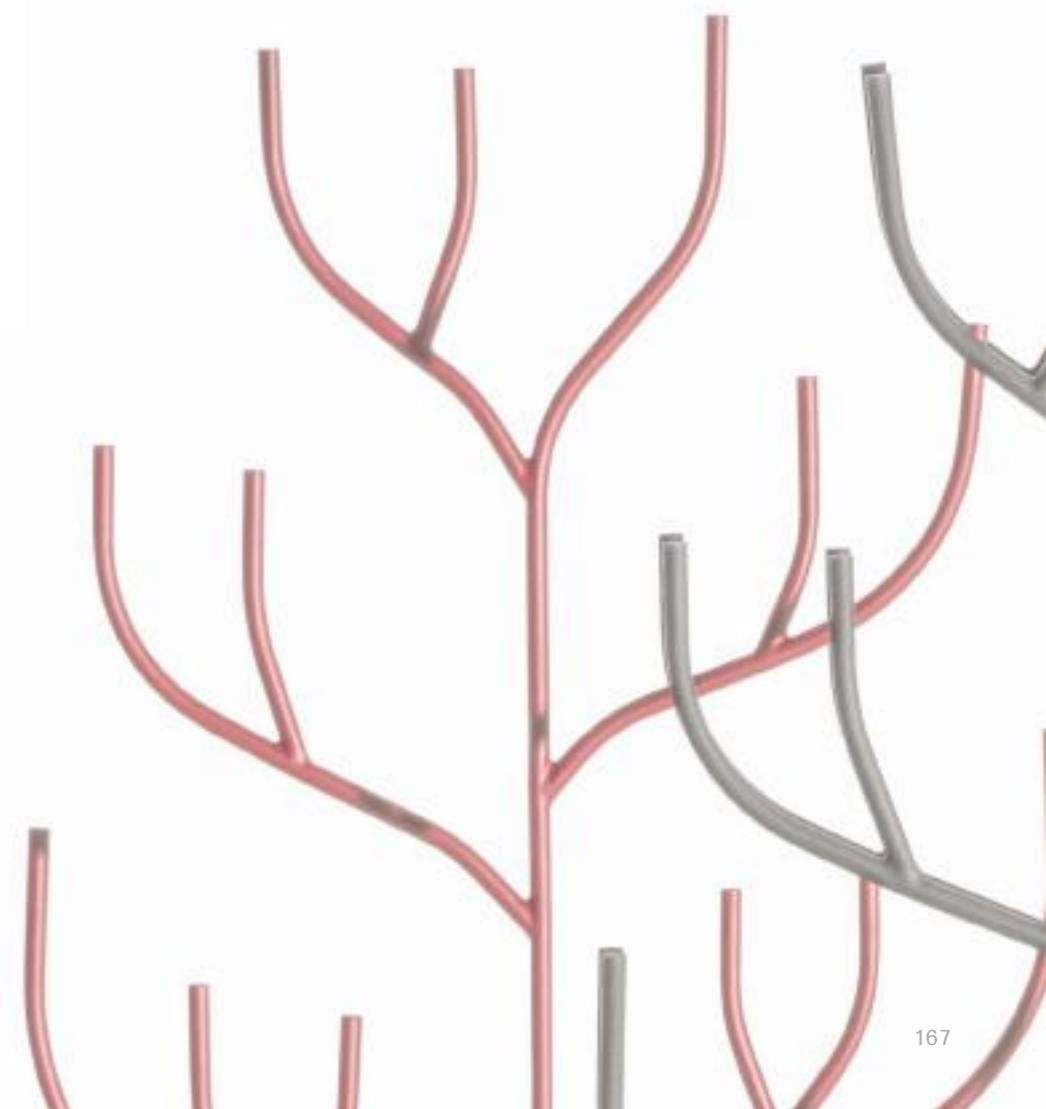

## acate

DESIGN \_ BOREK SIPEK



Ecco l'imitazione poetica di una natura capricciosa: virgulti che si abbracciano come sospinti da una passione d'amore, che li intreccia fra loro legandoli per sempre.

Here it is the poetic imitation of a capricious nature: shoots that become entangled as driven by the passion of love, which weaves them by tying them forever.





## **norma**

DESIGN \_ BOREK SIPEK

Un vento benevolo e bizzarro ha creato un tourbillon di foglie dorate: ne risulta un globo prezioso e seducente. Foglie in alluminio dorato e elementi in vetro soffiato.

A benevolent and bizarre breeze created a whirlwind of golden leaves: the result is a precious and seductive globe. Gilded leaves and blown glass elements.



## apollonio

DESIGN \_ BOREK SIPEK

Come un grappolo di bolle di sapone aggruppate intorno a una bolla più grande, che contiene la fonte luminosa; un gioco infantile cristallizzato nella realtà.

As a cluster of soap bubbles grouped around a larger bubble, which contains the light source: a childish game crystallized into reality.







## **lampsi**

DESIGN \_ PARK ASSOCIATI

Lampsi è composta da un nucleo centrale avvolto da una gabbia grafica rigorosa, un diamante stilizzato che brilla nell'aria ad illuminare gli ambienti, proiettando la sua sagoma.

Lampsi is made up of a central core surrounded by a graphic cage, a sketched diamond shining above and lighting up spaces.

**cut**

DESIGN \_ LUDOVICA + ROBERTO PALOMBA



# la bruyere

DESIGN \_ LINDE BURKHARDT

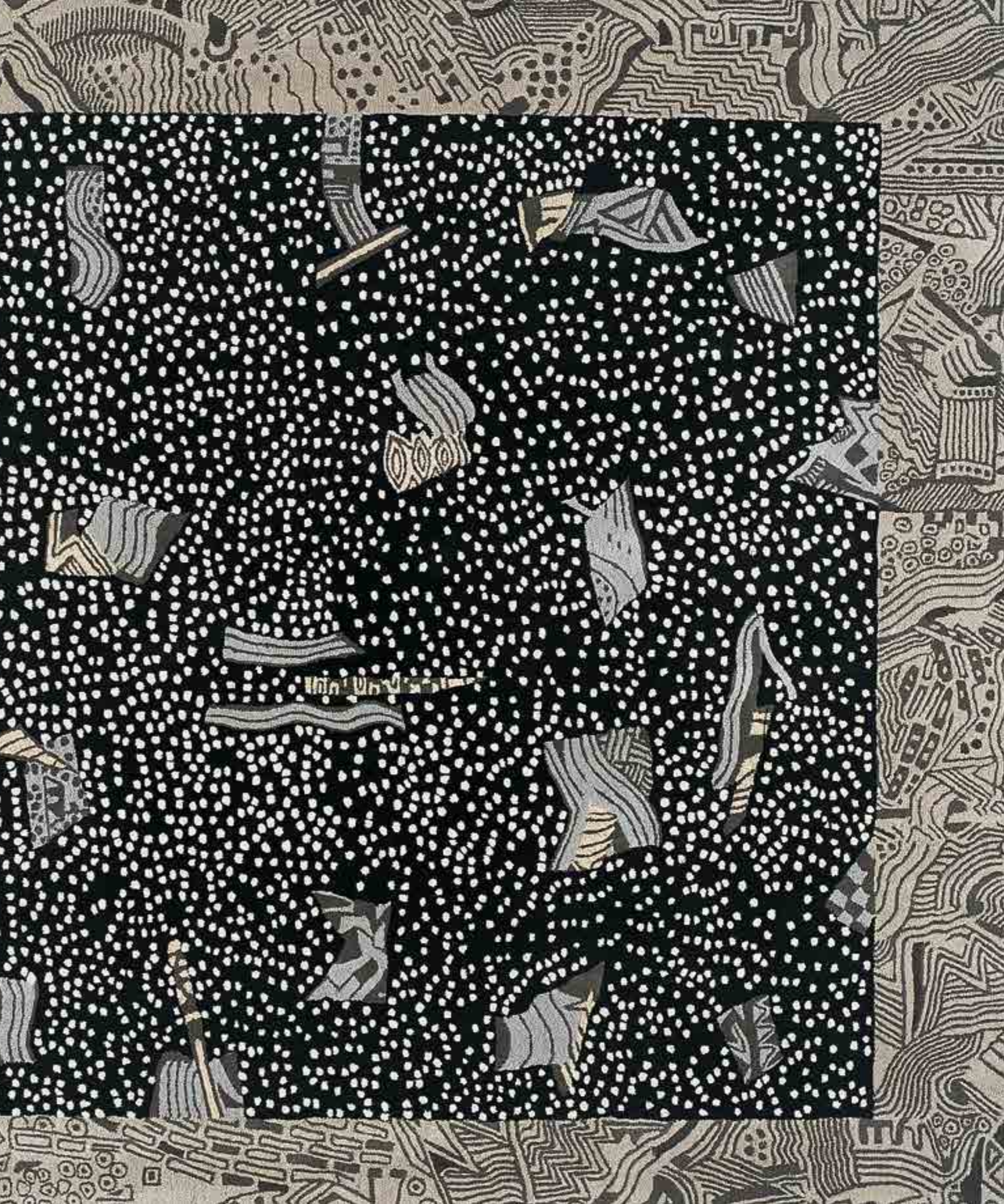



## la fontaine

DESIGN \_ LINDE BURKHARDT



**maud I, II**  
**mildred I, II**  
DESIGN \_ ANTONIA ASTORI

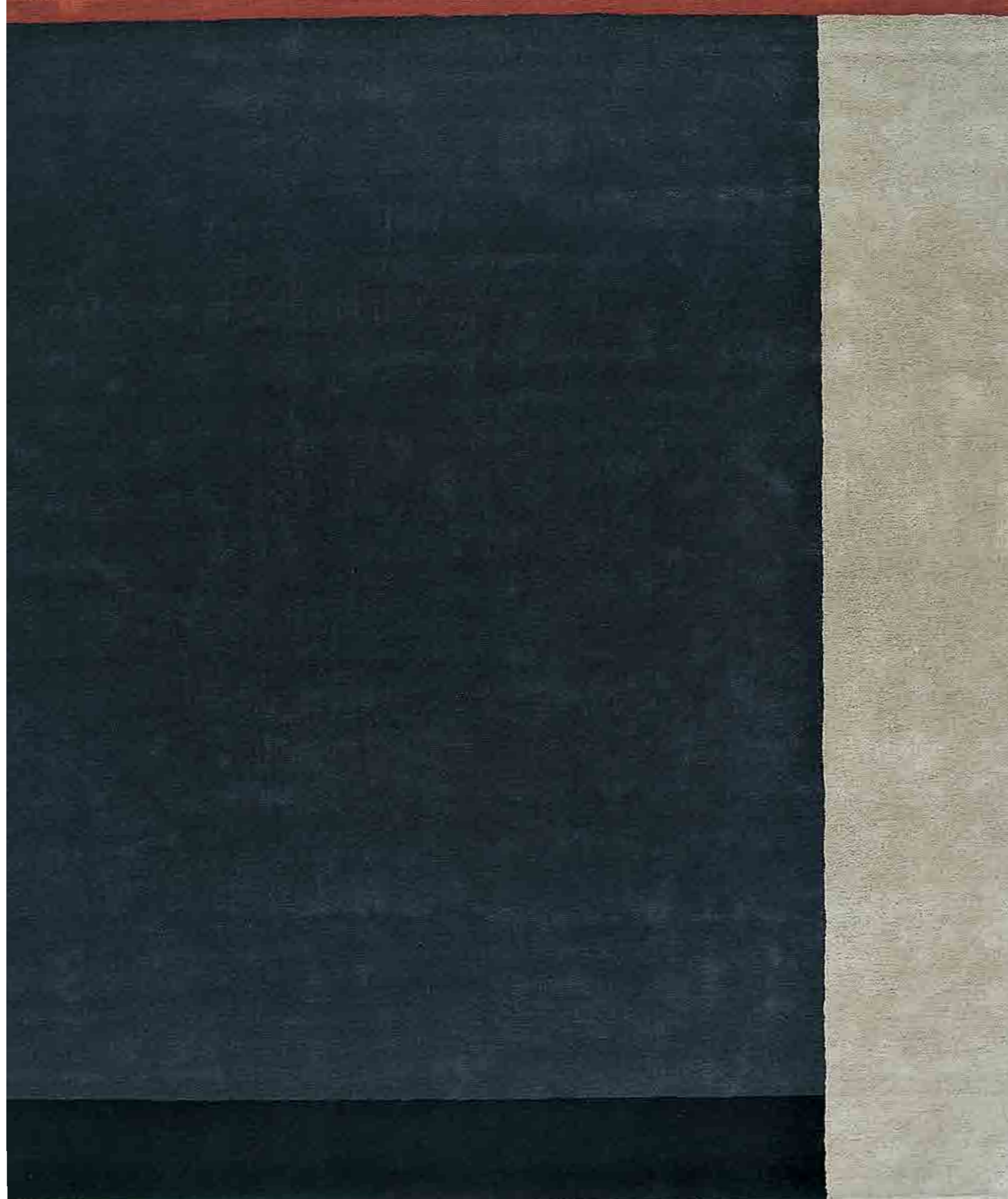
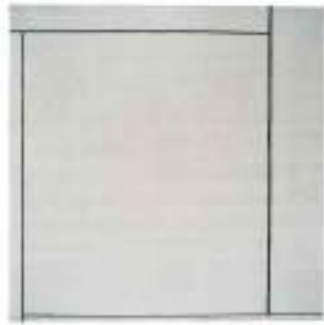



**yaschilan**

DESIGN \_ VITTORIO LOCATELLI



## uragano

DESIGN \_ LUDOVICA + ROBERTO PALOMBA



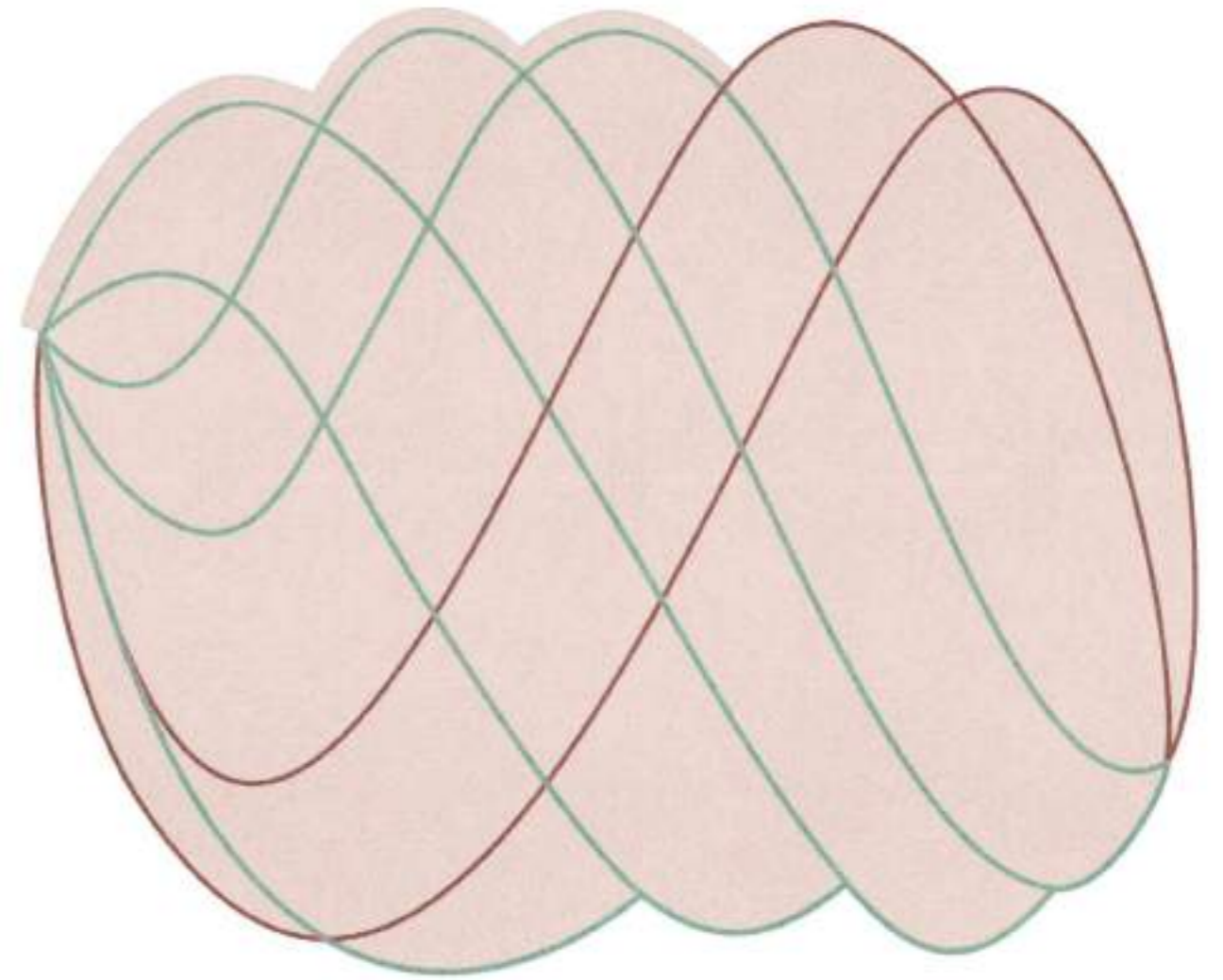
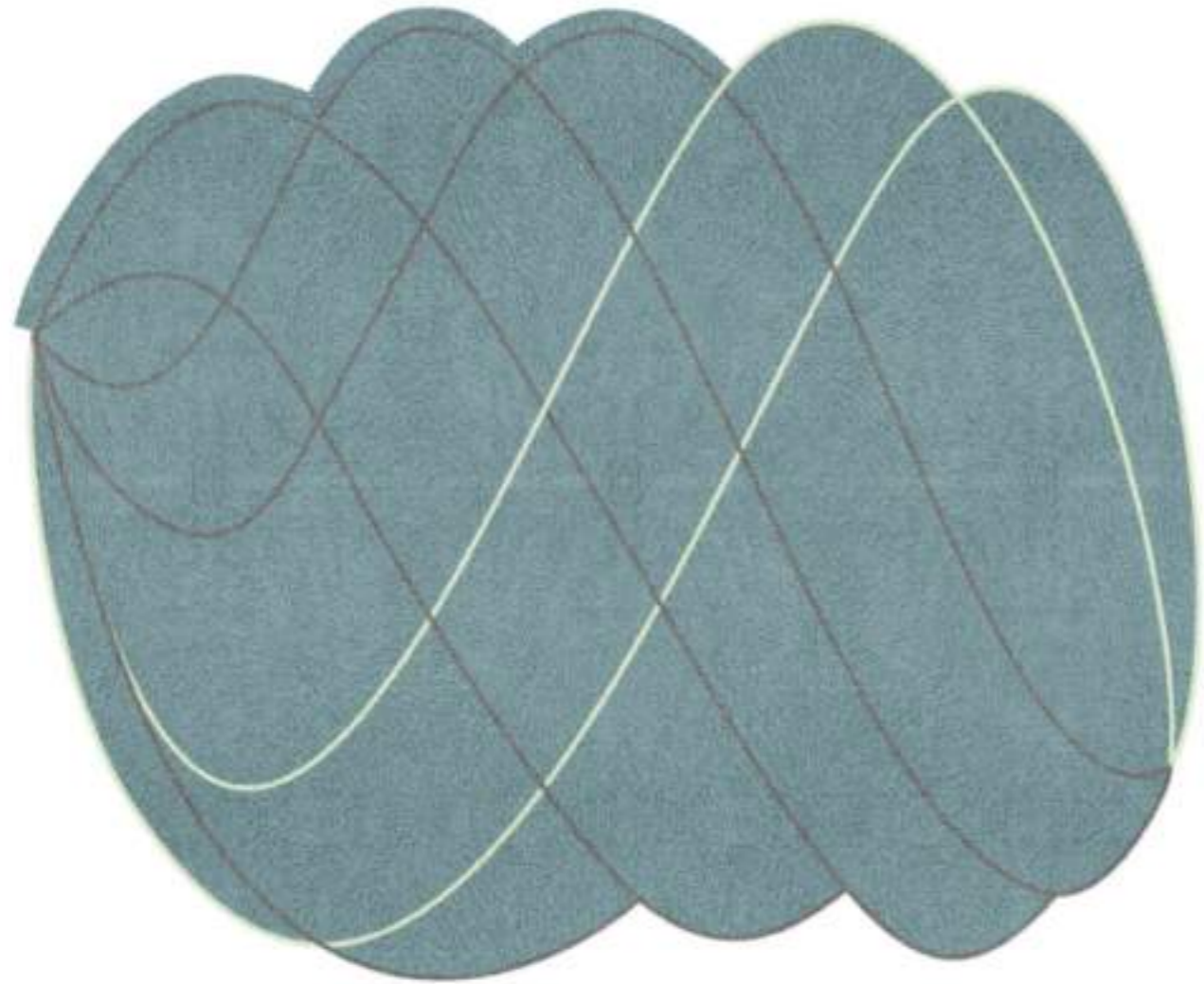

**twist**  
DESIGN \_ FRONT DESIGN



## no frame

DESIGN \_ ANTONIA ASTORI



La cornice c'è, strutturale, ma non si vede.  
Lo specchio è solo specchio: è solo se stesso,  
tautologico e affermativo.  
Che sia quadrato o rettangolare  
non ammette comunque intrusioni estranee.

The frame is there but you can't see it.  
The mirror is only mirror itself, tautological  
and affirmative. square or rectangular, however,  
doesn't allow foreign intrusion.





**miro**

DESIGN \_ FRANCESCO BOLIS



Un paravento-opera che, inaspettatamente, sul fronte posteriore propone uno specchio “a trittico” e un’immagine... Galleria Vittorio Emanuele.

An artistic screen that offers, unexpectedly, a “trptych” mirror on the rear side designed and one image... Galleria Vittorio Emanuele.

## archipelago

DESIGN \_ FREDRIKSON STALLARD



Tre specchi dai contorni frastagliati a evocare i profili irregolari di un'isola. Perfetti per ogni ambiente della casa, gli specchi possono essere proposti singolarmente o, a sottolinearne la forza espressiva, in un'armonica composizione.

Three mirrors with jagged frames that remind one of the irregular outlines of an island. Perfect for any room in the home. These mirrors can be used on their own or to form a harmonious composition, in order to highlight their expressive impact.



## egeso

DESIGN \_ BERTOCCO & LOCATELLI

Erbe di campo, mosse da un vento gentile, fanno da cornice, leggera e delicata, a uno specchio quadrato. dove immergersi per un attimo in una fresca natura.

Wild herbs, moved by a delicate breeze, frame, lightly and gently, a square mirror, where to dive, for a moment, into a fresh nature.



## taylor and snijder bird

DESIGN \_ ED ANNINK

Non sembra di ascoltare un lontano e sussurrato cinguettio? Un'illusione seducente, inaspettata e garbata.

Doesn't it seem to hear a far and whispered chirping? A seductive illusion, unexpected and delicate.





## osmond

DESIGN \_ PIETRO DEROSI

Un piano inclinato, ritagliato in una superficie specchiata più grande, che a sua volta diventa cornice, crea un effetto magico. L'immagine che ne risulta si frantuma e mette in evidenza dettagli nascosti.

An inclined plane, cut eccentrically on a mirrored larger surface, which becomes the total frame, creates a magical effect. The resulting image is shattered and highlights hidden details.





## erbale

DESIGN \_ BECCELLI, BORTOLANI, MAFFEI

Erbale è senz'altro uno dei progetti più longevi nel catalogo Driade. Ideato nel 1995 rappresenta in realtà una "invenzione di tipologia": mai infatti si era vista una "tenda-paravento" costruita con sacche in plastica alternate per il contenimento di piante e acqua. Erbale è, tra l'altro, divenuto nel tempo uno dei simboli della affermazione di una nuova generazione di designer italiani.

Erbale is definitely one of the longest lasting projects in Driade catalog. Designed in 1995, it was actually the "invention of a typology", as nobody had never thought before to a "screen-tent" constructed with plastic bags to contain plants and water. erbale has also become one of the symbol of the rising italian designers' new generation.

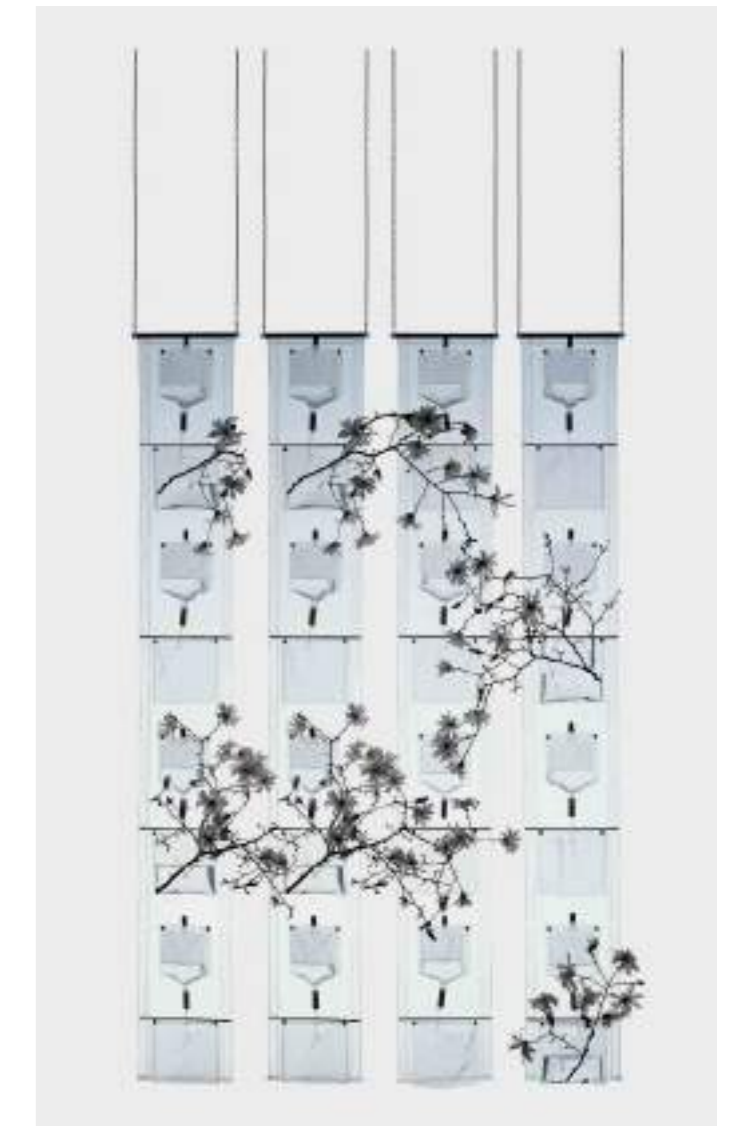

POLTRONE E DIVANI

---

# armchairs and sofas

---

I divani e le poltrone Driade si contraddistinguono per la forza e l'unicità delle loro caratteristiche; eclettici e giocosi ma allo stesso tempo eleganti e senza tempo sono protagonisti degli ambienti che animano. Sistemi componibili e pezzi singoli, chaise longue classiche e poltrone personaggio popolano il vasto catalogo Driade indoor e outdoor. Comodi e confortevoli sono ideali per il relax ed i momenti conviviali.

Driade sofas and armchairs are eclectic and joyful, elegant and timeless; they are protagonists of their inhabited spaces. Modular systems and unique pieces, classic chaise longues and protagonist armchairs populate the Driade catalogue. Comfortable pieces, perfect for relax and convivial moments.





## **lou read**

DESIGN \_ PHILIPPE STARCK WITH EUGENI QUITLET



Una poltrona personaggio, dalla sagoma organica.  
Interamente rivestita in pelle e cucita a mano.  
L'inaspettato confort è dato dalla perfetta ergonomia  
del manufatto.

An armchair/character with an organic outline.  
The armchair is entirely covered in leather  
and hand-stitched. The unexpected comfort is given  
by its perfect ergonomics.







## **lou speak**

DESIGN \_ PHILIPPE STARCK

Quando siedi su una Lou Speak sei costretto ad elevare il livello della conversazione. Se non lo fai, la tua poltrona risulterà più elegante di te. Philippe Starck. Si tratta dell'ampliamento della famiglia Lou. Ora è il momento di parlare. Questa poltrona girevole, comoda e avvolgente, segue infatti Lou Read e Lou Eat.

When you sit on a lou speak you are obliged to raise your level of conversation. If you don't, your chair will look more elegant than you do. Philippe Starck. This is an addition to the Lou family. It's now time to talk. this comfortable, cocooning, swivel chair has just shown up after Lou Read and Lou Eat.





## nemo

DESIGN \_ FABIO NOVEMBRE

Fabio Novembre utilizza il furniture design per raccontare delle storie. Storie intense e coinvolgenti ove sovente protagonista è la figura umana.

Una figura umana capace di farsi astratta e universale, capace di proporre una bellezza mitizzata come succedeva con l'arte greca. Così in Nemo un volto dalle sembianze classiche viene scavato per creare uno spazio abitabile.

Una testa-poltrona quindi, vissuta dall'interno e che, come una maschera, cela e contemporaneamente rivela il suo abitante.

Fabio Novembre uses furniture design to tell intense and fascinating stories in which the protagonist is often the human figure.

This human figure is capable of becoming abstract and universal, able to propose a mythic beauty as occurred in Greek art. So that Nemo, a face with classic features, is hollowed out to create an inhabitable space. The result is a head-armchair to be lived from the inside.

Like a mask, it simultaneously conceals and reveals its inhabitant.





## moon

DESIGN \_ LUDOVICA + ROBERTO PALOMBA

Per il progetto Moon e Full Moon, la scocca laccata o rivestita in pelle poggia su di un frame metallico dalla costruzione leggerissima che accoglie confortevolmente il corpo con seduzione e iconicità per un sottile gioco tra lo stupire ed il voler passare inosservati.

The lacquered shell of the Moon and Full Moon, sits on a very light metal frame or leather covered and comfortably pampers your body in a subtle, seductive interplay of amazement and understated iconic beauty.





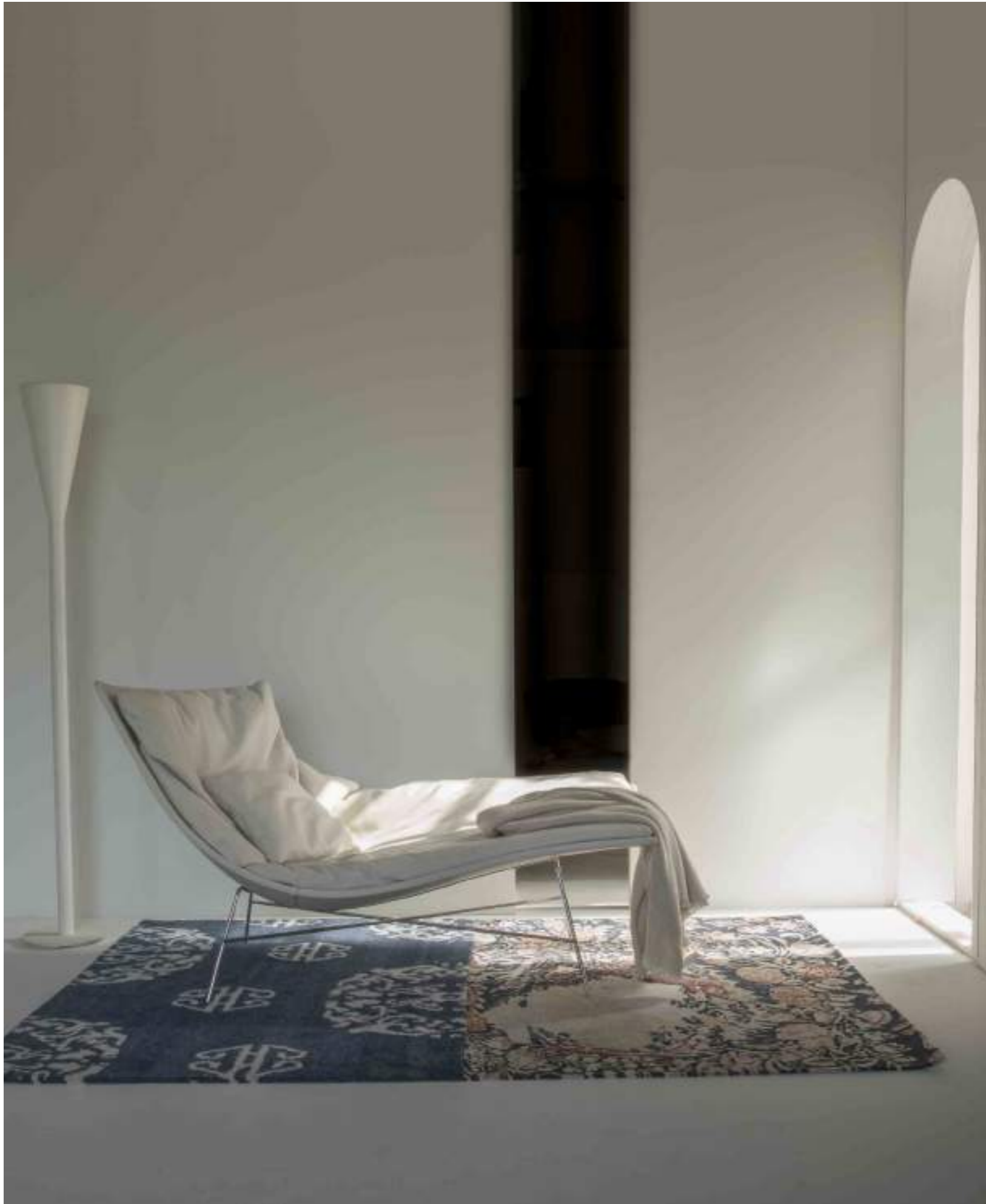

## full moon

DESIGN \_ LUDOVICA + ROBERTO PALOMBA



**cinemascope**  
DESIGN \_ PHILIPPE STARCK



“If all presidents and kings in the world had an exceptionally comfortable armchair like Cinemascope, can you imagine how their ideas, conversations and decisions would change? Cinemascope is the armchair that can save the world.”

PHILIPPE STARCK









## vigilius

DESIGN \_ MATTEO THUN & ANTONIO RODRIGUEZ



Comode sedute dal design classico e fortemente decorativo, perfette per arredare angoli contenuti così come ampi ambienti.

The cosy seats have a classic and very decorative design and are just perfect to furnish narrow corners or large spaces alike.



## ten

DESIGN \_ NAOTO FUKASAWA



La poltrona Ten, avvolgente e confortevole, si abbina al tavolino Ci, formando una zona lounge che si adatta armoniosamente ad ogni ambiente, dal classico al metropolitano.

The armchair Ten, which is cozy and comfortable, matches the small chair Ci, creating a lounge area that harmoniously blends into all interiors, from classical to metropolitan.





## **lisa**

DESIGN \_ LAUDANI & ROMANELLI

La poltrona diviene una poltroncina ovvero un “luogo individuale”, un “passepartout” per riscoprire riti dimenticati: poltroncine attorno al tavolo, nelle camere da letto o negli ingressi.

The armchair becomes an easychair and a “place for the individual”, a “passepartout” to forgotten customs: easychairs around tables, in bedrooms or in vestibules.





## meran

DESIGN \_ MATTEO THUN & ANTONIO RODRIGUEZ

Meran rimanda ad una sedimentata cultura dell'abitare che trova radici nella comodità borghese e nel rito dell'accoglienza.

Meran evokes a sedimented "living culture" rooted in bourgeois comfort and hospitality.



## moor(e)

DESIGN \_ PHILIPPE STARCK

Per Philippe Starck i nomi sono fondamentali, cifre di lettura del progetto. E allora Moor(e) vorrà proporre un omaggio al sommo scultore inglese Henry Moore? Certamente più che come un "oggetto d'uso" Moor(e) si presenta come una "scultura usabile". Perfetta per definire il concetto di "lusso contemporaneo" ovvero materia+tecnologia+comfort.

For Philippe Starck names are fundamental figures in a project decryption. So shall Moor(e) be a tribute to Henry Moore the great British sculptor? Certainly, more than as a "usable object", Moor(e) is presented as a "usable sculpture". Perfect for a definition of "contemporary luxury" so as material+comfort+technology.





## **s. marco**

DESIGN \_ MATTEO THUN & ANTONIO RODRIGUEZ

S.Marco e S.Marco lounge raccontano  
una cultura dell'abitare fatta di convivialità  
e di accoglienza.

S.Marco and S.Marco lounge evoke  
a sedimented "living culture"  
made of conviviality and hospitality.



**s. marco lounge**

DESIGN \_ MATTEO THUN & ANTONIO RODRIGUEZ





“A rare example of energy,  
courage and diversity.  
A truly unusual combination  
of thought and manual skill.  
In short, it is an example of how  
it is possible to bend the industry,  
each different industry in a different way,  
to our own vision of the world  
and to the result we want to obtain.”

PATRICIA URQUIOLA





**pavo**

**pavo real**

DESIGN \_ PATRICIA URQUIOLA

Patricia Urquiola compie una raffinata operazione di rivisitazione delle grandi poltrone in rattan e midollino diffuse nei paesi del sud-est asiatico. I volumi si dilatano, gli intrecci si raddoppiano, il decoro compare inaspettato con la seducente tattilità dei materiali naturali.



Patricia Urquiola makes a sophisticated review operation of those big rattan and cane armchairs so diffused in south-eastern Asia. Volumes expand, braids are doubled, patterns appear unexpectedly with the seductive tactility of natural materials.

## suki

DESIGN \_ TOYO ITO

Maestro dell'architettura, il giapponese Ito ha proposto, nel tempo, poche straordinarie prove da designer.

La poltrona Suki, progettata nel 1987, è una di queste: oggetto misterioso per l'adozione di un doppio filare di rete d'acciaio distanziato da numerose molle.

As a master in architecture, the Japanese Ito has proposed few but extraordinary design works. Suki armchair, designed in 1987, is one of them: an object made mysterious by the use of a double steel mesh row intersected by many springs.





“I am trying to counter the fixity  
of architectures, their stolidity,  
with elements that give  
an ineffable immaterial quality.”

TOYO ITO



## wow, wow low back

DESIGN \_ PHILIPPE STARCK

Wow è un sistema componibile estremamente ricco. Ai divani a due e tre posti si affiancano chaise longues ed elementi angolari che permettono di realizzare molteplici combinazioni. La forma segue la funzione primaria: la comodità.

Wow is a luxurious modular system. Besides two-seat and three-seat sofas, it includes chaise longues and corner elements conceived to define multiple layouts. The shape mirrors its primary function: comfort.





L'alto e avvolgente schienale  
e l'imbottitura in gomme  
poliuretaniche e piuma d'oca  
garantiscono la massima comodità.  
Questa è la garanzia del wow effect!

High enveloping backrest  
and polyurethane and goose down  
padding ensure an extreme comfort.  
This is the wow effect!





“One night I had a dream or, rather,  
a memory surfaced in my mind.  
I recall the delightful times  
when sofas were comfortable,  
and we shouted ‘wow,’ while leaping on them.  
I felt nostalgic for the past.  
And I thought that it was not bad after all,  
so I created Wow,  
the sofa that embraces you.”

PHILIPPE STARCK



## fenix

DESIGN \_ LUDOVICA + ROBERTO PALOMBA

Divano componibile in cui un'esile struttura metallica enfatizza il senso di sospensione da terra. La versione con terminali presenta una grande penisola dalla forma garbatamente asimmetrica.

Sectional sofa which thin metal structure emphasises the sense of suspension from the ground. The version with terminals presents a great peninsula from the gracefully asymmetric shape.







## **lirico**

DESIGN \_ LUDOVICA + ROBERTO PALOMBA

Lirico e Lirica.

Un sistema modulare e una poltroncina progettati dai designer Ludovica Serafini + Roberto Palomba. In questo caso, il duo si concentra sul tema della leggerezza, cercando forme sospese e lineari perché sembrino fluttuare, ottenuta con l'espedito del piede in fusione, dettaglio che caratterizza con grazia la personalità del divano. Il comfort di Lirico si rintraccia nella capacità di poter assemblare pochi elementi essenziali il cui dettaglio è sapientemente studiato.

Lirico and Lirica.

A modular system and a chair designed by Ludovica Serafini + Roberto Palomba. In this case, the duo has focused on the theme of lightness, looking for floating, linear shapes that appear to be fluctuating above the floor. They have achieved this by means of the masterly use of cast feet: a graceful, distinguishing detail of this sofa's personality. Lirico's comfort stems from the fact that it is made up of just a few, essential parts with cleverly-devised details.







## **lirica**

DESIGN \_ LUDOVICA + ROBERTO PALOMBA





my last **hotel**, or my next **home**.

## **hall**

DESIGN \_ RODOLFO DORDONI

Hall rilegge il classico capitonné da club inglese riportandolo ad una dimensione di comfort domestico.



Hall makes over the classic quilted upholstery typical of British country club sofas to adapt it the requirements of domestic comfort.





## **megara**

DESIGN \_ GORDON GUILLAUMIER

Megara si contraddistingue per le linee arrotondate dello schienale che si curva per dar vita al bracciolo, interrompendosi prima nell'incontro con la seduta a creare un raffinato dettaglio.

An exercise in style, refinement and essentiality, the Megara features a round backrest that smoothly flows into the armrest and creates a refined detail just before meeting the seat.







## neil

DESIGN \_ LUDOVICA + ROBERTO PALOMBA

Neil Armstrong, saltellando in completa assenza di gravità sul terreno lunare ha consacrato per sempre l'idea di leggerezza. È proprio al concetto "ungravity" a cui si sono ispirati Ludovica Serafini + Roberto Palomba per il nuovo divano Neil per Driade. Neil sofa si contraddistingue per la sua semplicità e per la sua compattezza, contiene un'anima assolutamente inaspettata, grazie alle imbottiture elastiche che al loro interno racchiudono un telaio tecnologico che rende flessibili sia i braccioli che gli schienali su cui potersi appoggiare in completo relax, senza stravolgere la struttura del divano. Nuovo intimo rifugio con un'estrema comodità di seduta sulla quale anche un semplice sonnellino diventa una passeggiata sulla luna.

When he walked on the moon in complete absence of gravity, Neil Armstrong forever consecrated the concept of lightness.

For the new Neil sofa designed for Driade, Ludovica Serafini + Roberto Palomba drew their inspiration from the same concept of weightlessness.

This sofa stands out for its simple lines and compactness and contains a totally unexpected soul: without altering the structure of the sofa, its elastic padding encloses a technological framework that makes the arm and backrests flexible, favouring complete relaxation. A new, intimate refuge featuring extremely comfortable seats on which even a small nap comes as easily as walking on the moon.









27

28

29

30

31

32



### 33 cuscini

DESIGN \_ PAOLO RIZZATTO

Divano gioiso e dal design unico.  
L'imbottito torna all'origine del suo percorso evolutivo quando altro non era che una serie di cuscini appoggiati su una panca.  
Il designer "blocca" i cuscini, li rende "strutturali" e inventa una nuova forma di macro capitonné ove ogni singolo modulo conserva una precisa identità.

Joyful sofa with unique design.  
The sofa gets back to the origin when it was nothing more than a lot of pillows leaning on a bench. The designer draws a new form of macro capitonné where each module retains its own identity.





## leeon soft

DESIGN \_ LUDOVICA + ROBERTO PALOMBA

Divano decorativo ed elegante, si contraddistingue per il damier della trapuntatura e per i supporti puntuti. Ne discende un progetto ampiamente declinato, utilizzabile in ambienti pubblici e privati.



Decorative and elegant sofa, characterized by the damier decoration and the straight cast-aluminum structure. The result is an extended project, meant to be used both in private and public areas.





## rever

DESIGN \_ LUDOVICA + ROBERTO PALOMBA

Rever è il prodotto young della collezione Driade. Morbido, generoso nelle curve e nelle proporzioni. Un originale incastro di braccioli, caratteristica fondamentale del sofà, e particolare attenzione al dettaglio: un bordo leggermente imbottito che sembra rubato all'immaginario della moda, poiché ispirato ai bavero delle giacche e alle pattine delle tasche. Rever è un divano estremamente versatile. Le ampie dormeuse e i comodi pouf lo rendono piacevolmente adatto alla convivialità e al gioco.

Rever features plump, generous curves and proportions. The original way the armrests are fitted - a fundamental feature of this sofa - is paired with special attention to detail: the slightly padded edge looks as if it comes from a fashion house because it is inspired by the lapel of jackets and the flap of pockets. Rever is an extremely versatile sofa. The large day beds and the comfortable poufs make it perfect for moments of enjoyable togetherness and play.





“I have always perceived  
a touch of the French culture  
in the eclectic identity of way  
of mixing different styles  
of furniture, contemporary objects”.

ALBERTO LIEVORE





## **verlaine**

DESIGN \_ LIEVORE ALTHERR MOLINA

Grazie alla sua affascinante silhouette, Verlaine diviene il principale dettaglio estetico del living room, seduce gli occhi, cattura l'attenzione, invita alla prova.

Verlaine fascinating silhouette is an irresistible attraction inviting the viewer to appreciate the comfortable seat. Verlaine becomes the main aesthetic detail of the living room; it entices the eyes and grabs the attention.





## elisa

DESIGN \_ ENZO MARI

Divano dal design minimale ed elegante,  
sintesi di leggerezza e comfort.

Sofa with an elegant and minimal design,  
perfect blend of lightness and comfort.



**mod**

DESIGN \_ LUDOVICA + ROBERTO PALOMBA



La semplicità è, per lo studio Palomba + Serafini, talvolta, un'intuizione ove la geometria rigorosa delle forme si rinnova, senza abbandonare i principi dell'eleganza più pura e il minimalismo più essenziale.

Le linee di questo divano componibile non sono mai interrotte da elementi che tradizionalmente separano; l'ampia seduta è sorretta dal piede incorporato nella struttura del divano stesso, un'innovazione che appare ovvia, in realtà inedita.

For the Palomba + Serafini studio, simplicity is sometimes an intuition in which the rigorous geometry of forms is renewed without abandoning the principles of the purest elegance and of the most essential minimalism. The lines of this modular sofa are never interrupted by elements that traditionally create a separation; the large seat stands on feet that are integrated in the frame of the sofa itself, an innovation that may seem obvious, but that is really brand new.





## **mody**

DESIGN \_ LUDOVICA + ROBERTO PALOMBA



La poltroncina Mody completa il progetto Mod. Ha carattere deciso e una personalità attraente. Perfetta per l'intimità domestica come per la convivialità degli spazi pubblici.

Mody completes the Mod project with a bold character and an appealing personality. Perfect for the domestic intimacy as well as for the public spaces.



## neoz

DESIGN \_ PHILIPPE STARCK

Neoz è un “nido abitabile” caratterizzato dal candore dei tessuti orlati a giorno, come nella biancheria di un tempo, e dalla morbidezza dei numerosi cuscini. Le grandi ruote suggeriscono un’atmosfera lussuosamente provvisoria.

Neoz is a sort of “living nest” marked by the hem-stitched tissue whiteness, like past laundry, and the cushions’ softness. Large wheels, though, suggest an only temporary luxe.



## garçonne

DESIGN \_ CARLO COLOMBO

Completato dalla poltrona, Garçonne è un pezzo protagonista dello spazio, adatto sia ad un uso conviviale che ad un uso domestico.

Completed by the armchair, Garçonne is a luxury item, a fully fledged protagonist, designed for people who love meeting friends and relaxing with their family.



LETTI

beds



Poesia e unicità sono le cifre che accomunano i letti di design della collezione Driade:

Edward, letto a baldacchino dalle lavorazioni preziose;

Leeon, letto matrimoniale dall'estetica ricercata ispirata all'edonismo degli anni '80;

Neoz, letto imbottito dai tessuti orlati a giorno dotato di ruote.

Profondamente diverse tra loro, queste proposte rispondono alle esigenze di un consumatore contemporaneo e sofisticato, amante del bello, romantico e ironico al tempo stesso.

Poetry and uniqueness are the main characteristics of Driade beds:

Edward, precious canopy bed; Leeon, a bed inspired by the 80s

hedonism; and Neoz, a textile bed on wheels. Deeply different one

from the other these projects answer to the needs of a modern and sophisticated consumer.





## neoz

DESIGN \_ PHILIPPE STARCK



Neoz è un “nido abitabile” caratterizzato dal candore dei tessuti orlati a giorno, come nella biancheria di un tempo, e dalla morbidezza dei numerosi cuscini. Le grandi ruote suggeriscono un'atmosfera lussuosamente provvisoria.

Neoz is a sort of “living nest” marked by the hem-stitched tissue whiteness, like past laundry, and the cushions' softness. Large wheels, though, suggest an only temporary luxe.



## leeon

DESIGN \_ LUDOVICA + ROBERTO PALOMBA



Letto sofisticato ed elegante, si contraddistingue per il damier della trapuntatura e per i supporti puntuti in fusione di alluminio lucidato o verniciato.

Sophisticate and elegant bed, characterized by the damier decoration and the straight cast painted or polished aluminum structure.





**edward. I, II, III, IV**  
 DESIGN \_ ANTONIA ASTORI



Romantic letto a baldacchino  
 realizzato con materiali  
 e lavorazioni preziose.

Romantic canopy bed realized  
 with precious materials  
 and manufacturing.

outdoor



in or out





## nemo

DESIGN \_ FABIO NOVEMBRE

Fabio Novembre utilizza il furniture design per raccontare delle storie. Storie intense e coinvolgenti ove sovente protagonista è la figura umana.

Una figura umana capace di farsi astratta e universale, capace di proporre una bellezza mitizzata come succedeva con l'arte greca. Così in Nemo un volto dalle sembianze classiche viene scavato per creare uno spazio abitabile. Una testa-poltrona quindi, vissuta dall'interno e che, come una maschera, cela e contemporaneamente rivela il suo abitante.

Fabio Novembre uses furniture design to tell intense and fascinating stories in which the protagonist is often the human figure.

This human figure is capable of becoming abstract and universal, able to propose a mythic beauty as occurred in Greek art. So that Nemo, a face with classic features, is hollowed out to create an inhabitable space. The result is a head-armchair to be lived from the inside. Like a mask, it simultaneously conceals and reveals its inhabitant.

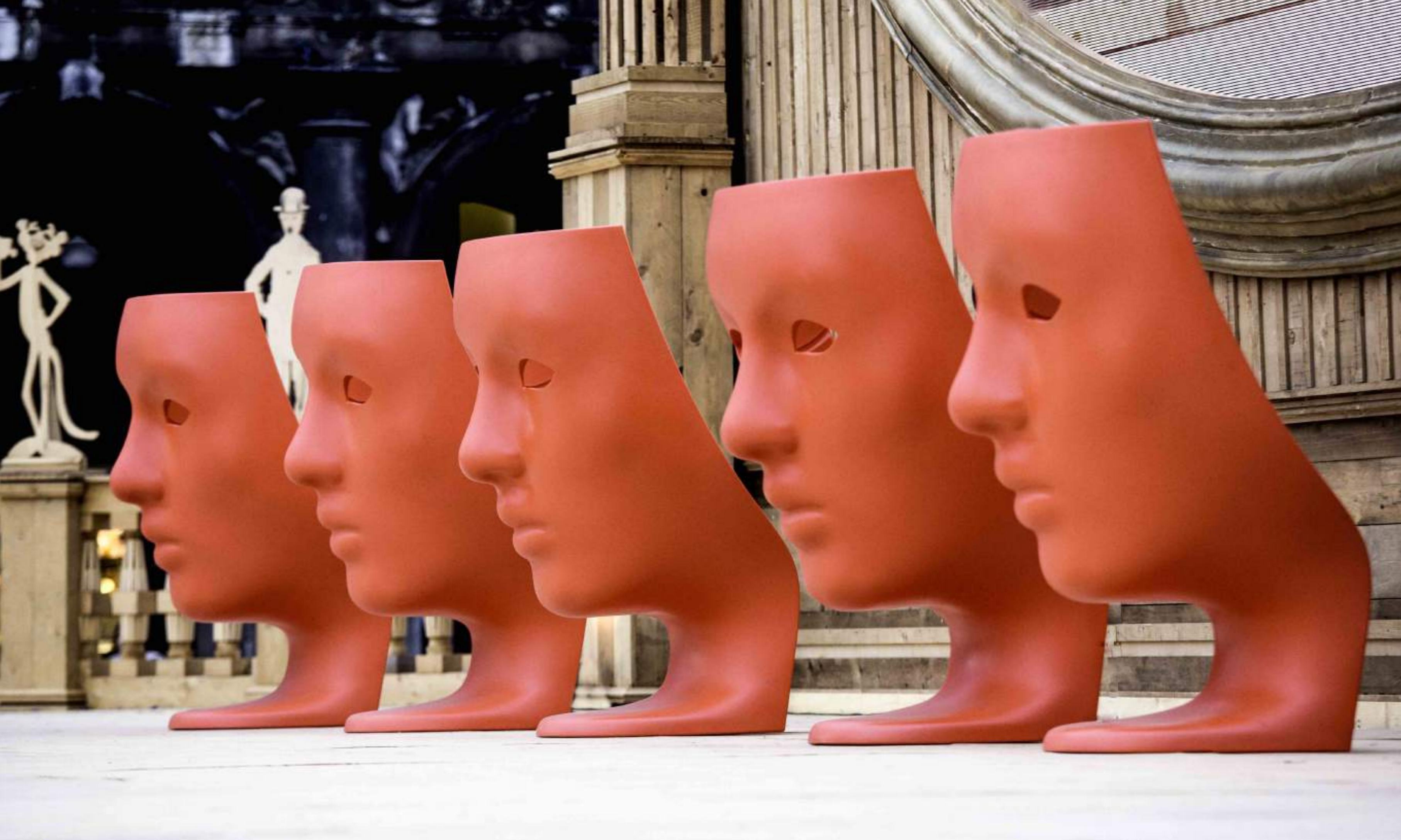





## roly poly

DESIGN \_ FAYE TOOGOOD

Le caratteristiche linee massicce e rassicuranti della collezione di mobili Roly Poly di Faye Toogood diventano ancora più accattivanti nella sua nuova collaborazione con Driade. L'ultima linea della design house italiana assume le forme arrotondate e accoglienti della sua collezione in edizione limitata, assemblage no 4. La seduta bassa è stata alzata con cuscini imbottiti che si accomodano nella sua forma curva a ciotola; la collezione presenta anche un nuovo divano che esplora ulteriormente l'estetica di Roly Poly, evidenziando l'interazione tra il grazioso arco della seduta a cucchiaio e le quattro gambe corpulente e solide che la sostengono.

The distinctive, reassuringly chunky lines of Faye Toogood's Roly Poly furniture collection become even more inviting in her new collaboration with Driade. The latest line for the Italian design house takes the rounded, welcoming shapes of her limited-edition assemblage no 4 range. The low seat has been augmented with upholstered cushions that nestle in its curved, bowl-like form; the collection also features a new sofa that further explores the Roly Poly aesthetic, highlighting the interplay between the graceful arc of the scoop seat and the four stout and solid legs that support it.







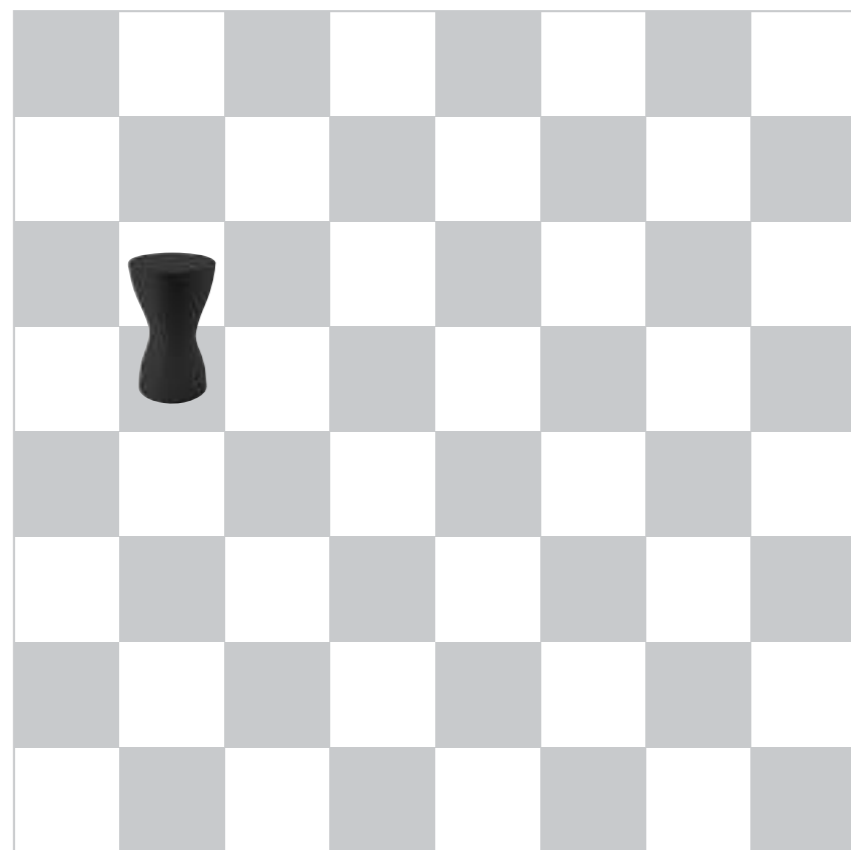

## tokyo-pop

DESIGN \_ TOKUJIN YOSHIOKA



Il divano, la poltrona e soprattutto la chaise longue e lo sgabello, lontani dalla banalità della plastica, sono vere e proprie sculture. Forme indimenticabili e inusitate.

The sofa, the armchair and above all the chaise longue and the stool, far from the banality of rotational molding are true sculptures. Unforgettable and unusual forms.







**pliè**  
**grand pliè**  
**piaffè**

DESIGN \_ LUDOVICA + ROBERTO PALOMBA

Un divano da esterno, disegnato  
“per la conversazione”, arte antica e nobilissima.  
Un divano sul quale ognuno può trovare  
la sua profondità di seduta e la sua posizione  
ideale: più composta o più dolcemente rilassata,  
a seconda del temperamento o delle occasioni  
della giornata.



An outdoor sofa designed for the ancient  
and very noble art of conversation.  
In this sofa everyone can find his ideal depth  
of seating position and posture: more composed  
or more gently relaxed, depending on one's  
temperament or the circumstances of the day.

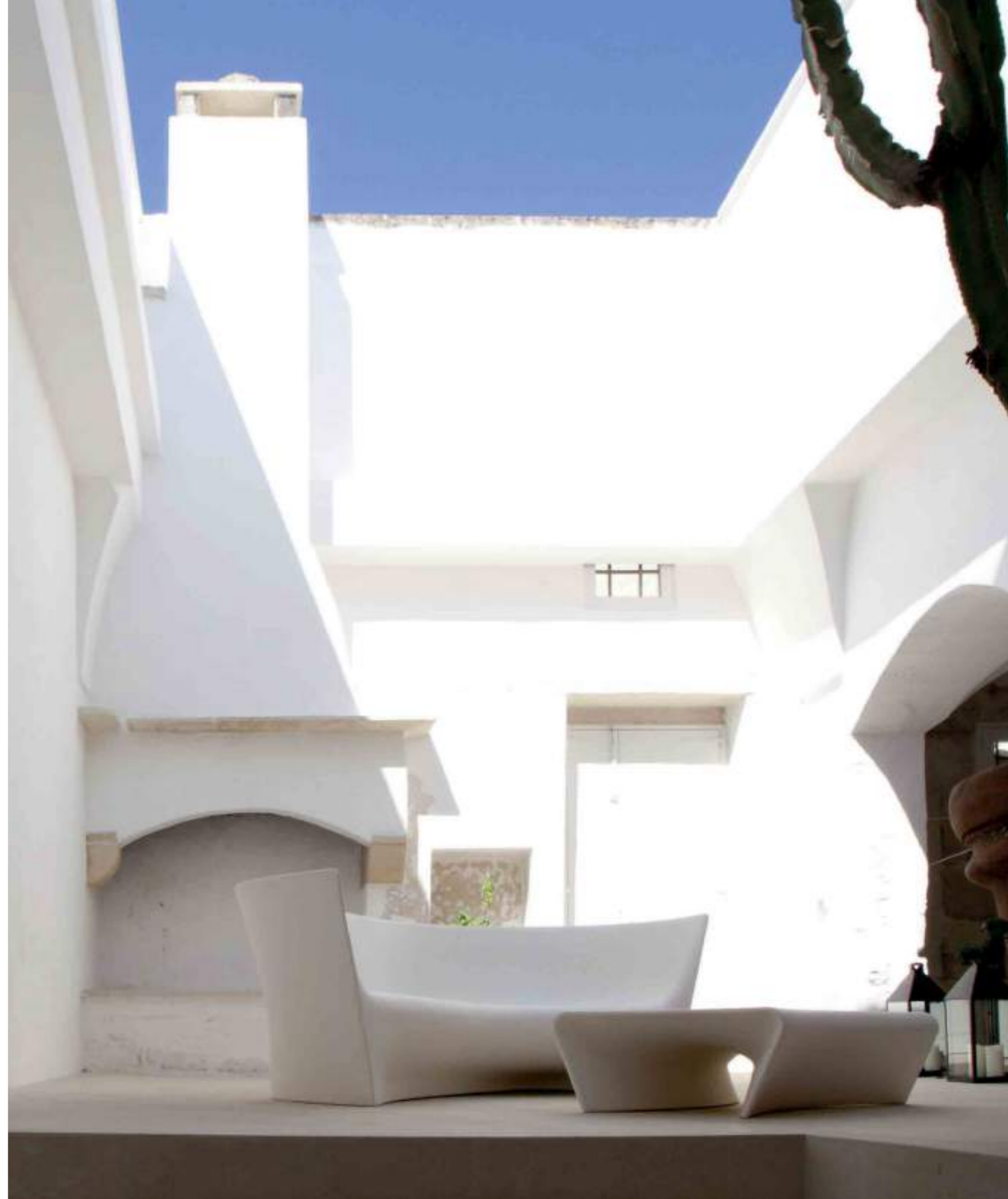



## mt1 mt2 mt3

DESIGN \_ RON ARAD



“MT”, sigla che denomina questi pezzi progettati da Ron Arad, si pronuncia in lingua inglese “empty” vale a dire “vuoto”.

Il vuoto è l'elemento caratterizzante di questo progetto. Il volume viene scavato e presenta provocatoriamente il suo interno, finito in rosso o nero.

“MT”, the acronym defining this collection designed by Ron Arad, in English is pronounced “empty” that means “vacuum”. Emptiness is really the key element of this project.

The volume is hollowed and presents provocatively its interior, finished in red or black color.







# mingx

DESIGN \_ KONSTANTIN GRČIČ

Sedia, poltrona, poltroncina  
e sgabelli caratterizzati dal profilo  
in tubolare.  
Seduta con cuscino per l'outdoor.  
Proposta nei colori bronzo, nero  
e arancio.

Chair, armchair, easychair,  
and stools characterized by a tubular  
profile. Cushion seat for outdoor.  
Colors: orange, bronze and black.



## camouflage

DESIGN \_ FREDRIKSON STALLARD

Camouflage è una collezione per outdoor composta da poltrona alta, bassa, e tavolini realizzati in alluminio. Prodotti scultorei, dove il design geometrico della struttura fa da cornice all'elaborato decoro traforato.

Camouflage is an outdoor collection that includes a high and low armchair and small tables, all made of aluminium.

In these sculptured elements the geometrical design of the structure frames the elaborated fretworked decoration.

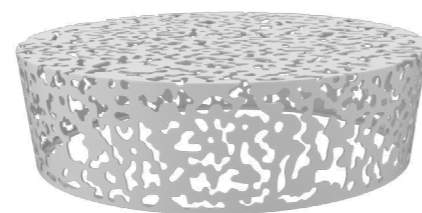



## elisa

DESIGN \_ ENZO MARI

Divano dal design minimale ed elegante è perfetto per arredare patii, terrazze e giardini con un tocco di leggerezza.

Sofa with an elegant and minimal design, is perfect for decorating patios, terraces and gardens with a touch of lightness.





## sunrise

DESIGN \_ LUDOVICA + ROBERTO PALOMBA

Alle poltroncine e al divanetto Sunrise si abbina una collezione di tavoli e tavolino in alluminio verniciato bianco caratterizzati da una gamba elegantemente affusolata, ma soprattutto dalla decorazione del piano. Su di esso si rincorrono infatti segni misteriosi, antiche incisioni come un alfabeto.



The chairs and sofa Sunrise combines with a collection of tables and coffee table in white painted aluminum, featuring by an elegantly tapered leg, but also by the decoration of the top. On it, you can chase mysterious signs and old engravings, as an alphabet.

## hervé

DESIGN \_ LIEVORE ALTHERR MOLINA

Hervé è un progetto che, volendo dare vita ad una famiglia di sedute outdoor, si ispira a forme vegetali, arbusti, rami che si trovano nel giardino dove si colloca. Sono i rami stessi, tradotti in strutture metalliche sottili, a formare le varie sedute di cui si compone. Una leggera housse semi-trasparente ne lascia intravedere le trame e rende le sedute ancora più abitabili. Sino all'arrivo dell'inverno successivo, quando cuscini e housse, riposti all'interno, lasceranno nel giardino le strutture ramificate che si confonderanno con la natura sino alla prossima estate.

Since the idea behind this project was to create a family of outdoor seats, Hervé is inspired by the plants, shrubs and branches typical of the environment it will stand in. The various seats it is made up of are reminiscent of the same branches that together build a slim, metal framework. A light, semi-transparent cover lets you catch a glimpse of the framework while making the seats even more homely. Until winter comes and the cushions and cover, stored indoors, leave the branched framework in the garden to mingle with its natural surroundings until the summer comes back again.

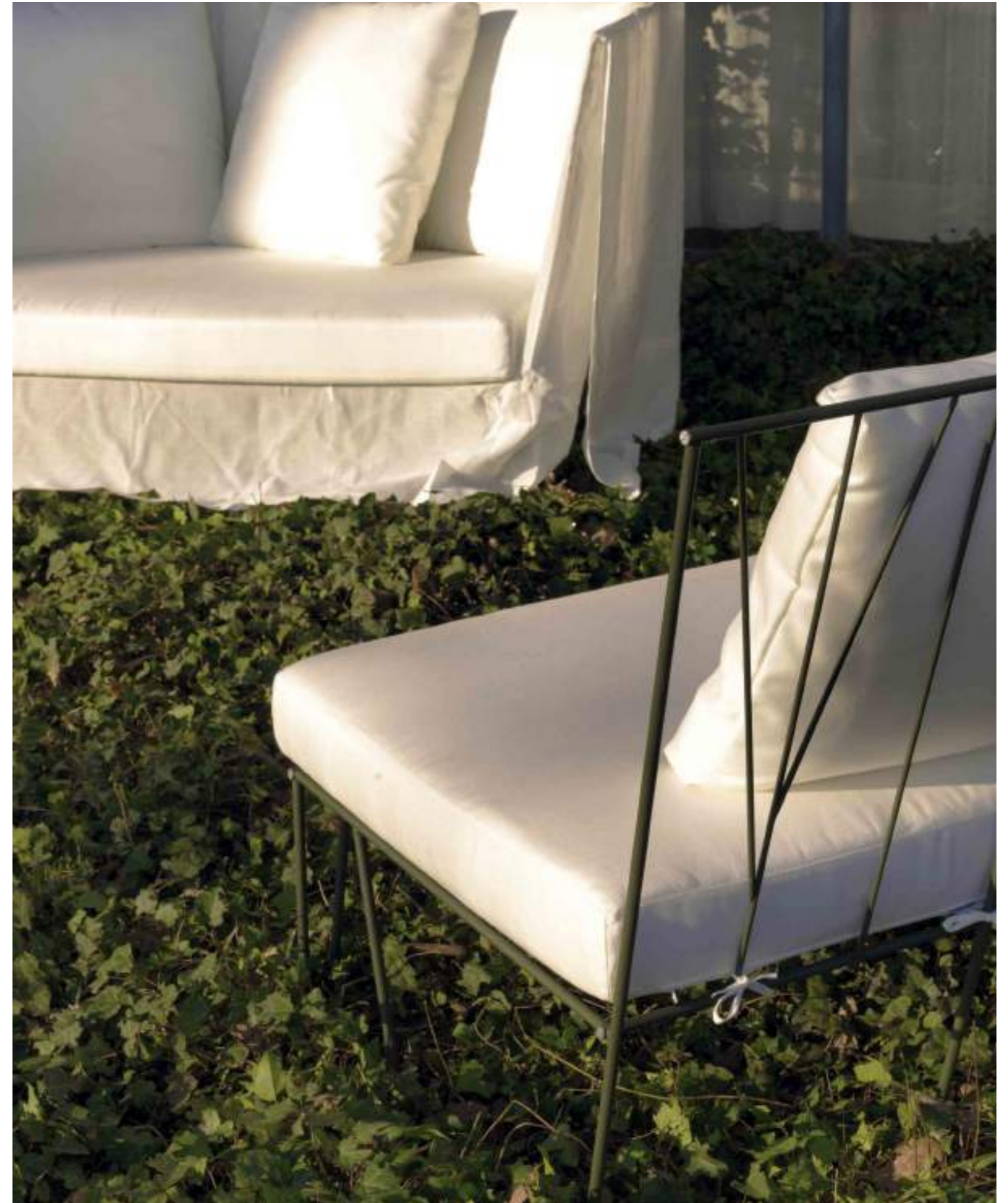



## sissi

DESIGN \_ LUDOVICA + ROBERTO PALOMBA

È un progetto moderno che ammicca sfrontato al passato e al mondo femminile. Gli anelli che si fondono sembrano piegati a mano e le loro sensuali connessioni fanno di Sissi un oggetto raffinato e scultoreo, proprio come la sedia viennese per eccellenza, famosa per le sue curvature in legno. Una sedia che si completa grazie al suo rivestimento del sedile, parte integrante del progetto stesso, che proprio come una donna disinvolta e sicura di sé cambia d'abito a seconda dell'umore.

Its modern design winks cheekily at the past and at the female world.

The merging and intersecting rings look as if they have been bent by hand and are linked in such a sensual way as to turn Sissi into a refined and sculptural piece, just like the ultimate Viennese chair - famous for its wooden curves - it is reminiscent of.

Like a confident, self-assured woman changes her clothes to suit her mood, this chair is complemented by an essential part of its design, the seat cover.





## **pip-e**

DESIGN \_ PHILIPPE STARCK, EUGENI QUITLET

In Pip-e la successione degli elementi orizzontali, che creano seduta e schienale, assume una valenza fortemente chiaroscurale e prosegue, in modo inaspettato, ad accompagnare la curvatura interna del ginocchio. Varianti: sedia e poltroncina.

The sequence of horizontal elements which creates the seat and the back definetly takes on a strong chiaroscuro and accompanies the bending of the knees. Versions: chair and armchair.





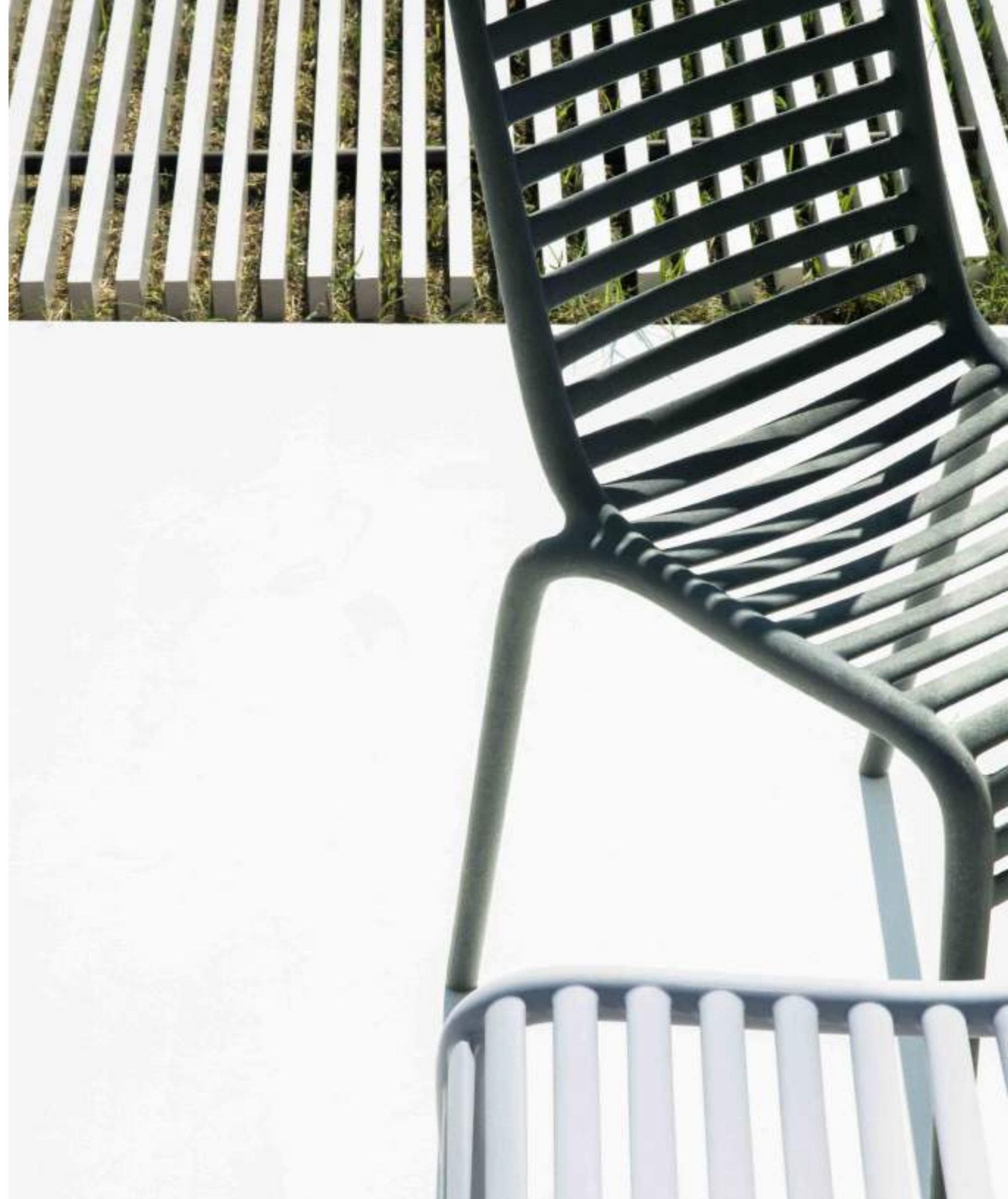



## toy

DESIGN \_ PHILIPPE STARCK



Una poltroncina volutamente astratta nella sua composizione e, proprio per questo, confortevole in modo imprevedibile.

Apparentemente scavata in un blocco, Toy parla un linguaggio di spigoli vivi e larghi piani che la rendono diversa dalle altre sedie in polipropilene stampato oggi disponibili sul mercato. In questa sua connotazione Toy appare unica persino all'interno del corpus progettuale di Philippe Starck.

A chair deliberately abstract in its composition and, for this reason, comfortable in unpredictable ways. Seemingly carved into a block, Toy speaks a language of sharp and broad plans that make it different from other molded polypropylene chairs. In this connotation Toy is unique even within the design corpus of Philippe Starck.





## lord yo

DESIGN \_ PHILIPPE STARCK



Inizialmente Lord Yo era semplicemente una poltroncina in polipropilene con struttura in alluminio, oggi è un'icona. Costruita con morbide curve e schienale rialzato; quasi un trono.

At its beginning, Lord Yo was simply a polypropylene easychair with an aluminum structure, now it's an icon. With soft curves and raised back; almost a throne.





**bo**

DESIGN \_ PHILIPPE STARCK

Sedia dalla silhouette slanciata ed ergonomica,  
perfetta per l'outdoor così come per gli interni  
più contemporanei.

Bo chair is characterized by a soar  
and ergonomic silhouette.  
Perfect for outdoor or contemporary indoor.



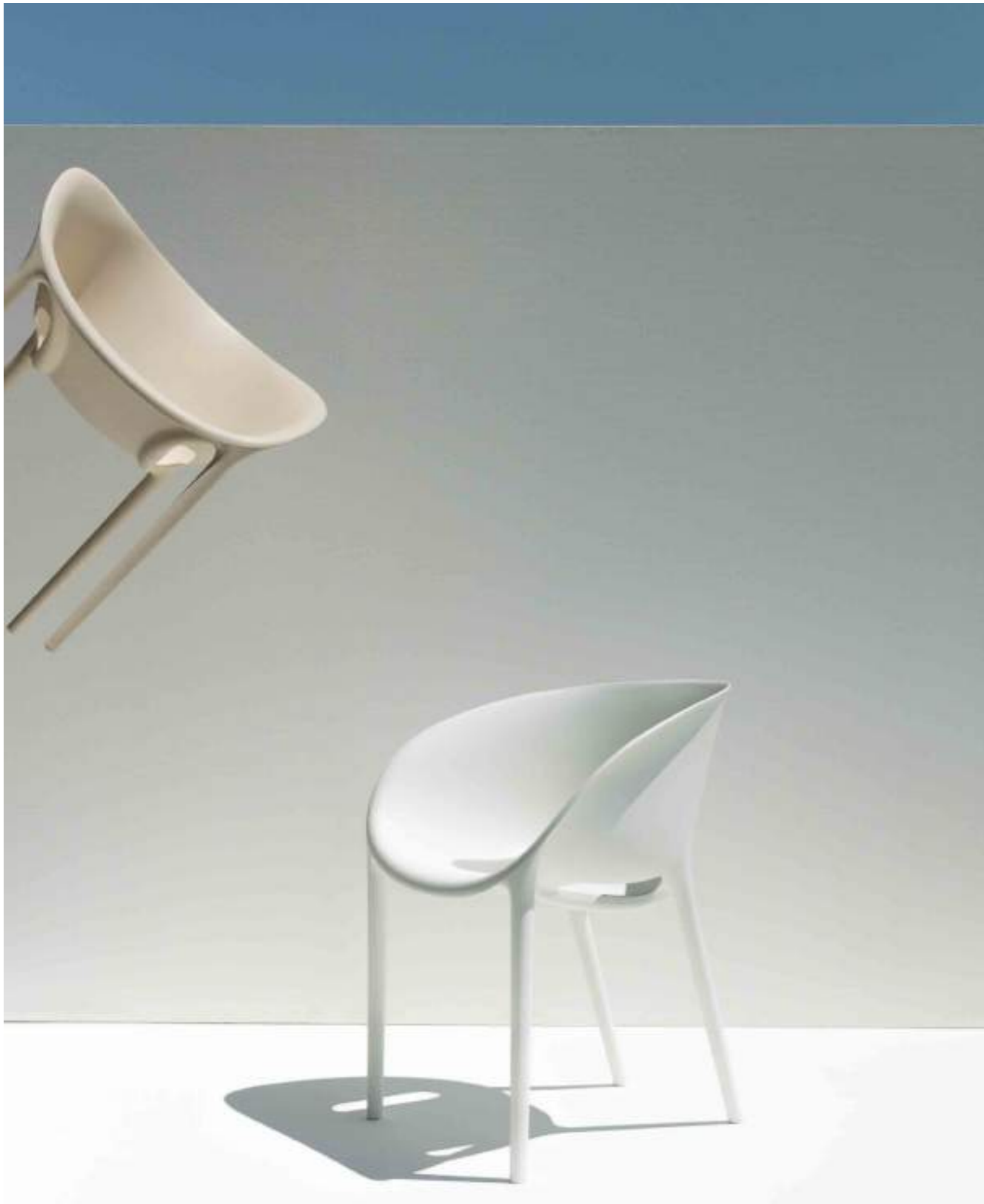

## soft egg

DESIGN \_ PHILIPPE STARCK



Una poltroncina che riprende le rotondità tipiche degli anni '50 rendendole tuttavia ergonomicamente corrette e per di più adatte ad un uso in esterni. "Soft Egg" propone un'immagine organica capace di fondersi, in modo incredibile, con la natura.

A chair that incorporates the rounded 50's style, however, ergonomically correct and more suitable for an outdoor use. "Soft Egg" offers an organic image that can melt, so amazingly, with nature.





## clover

DESIGN \_ RON ARAD



Le poltrone possono diventare fiori?  
Fiori di una specie sconosciuta dotati di quattro petali carnosì e di forti radici.

Can armchairs become flowers?  
Flowers of an unknown species with four fleshy petals and strong roots.





## modesty veiled

DESIGN \_ ITALO ROTA



La qualità di essere modesta: la libertà dalla vanità, riguardo per la decenza di comportamento, di linguaggio, d'abbigliamento, semplicità, moderazione, progettata per evitare l'esposizione accidentale di una parte del corpo, un lembo di pudore, di mansuetudine.

The quality of being modest: the freedom from vanity, the respect for discretion in the conduct, in the language, in the clothing, the simplicity, the moderation, designed to prevent the accidental exposure of a body part, a strip of modesty, of meekness.

## out/in

DESIGN \_ PHILIPPE STARCK WITH EUGENI QUITLET



Out/In procede secondo due traiettorie:  
dentro casa o fuori in giardino?

Out/In proceeds along two paths:  
at home or in the garden?







## app

DESIGN \_ LUDOVICA + ROBERTO PALOMBA

Il tavolino App, pensato principalmente per l'outdoor, offre possibilità di utilizzo poliedriche e trasversali. Slanciato ed elegante, è caratterizzato da un piano quadrato e da quattro gambe che si raccordano nella parte alta della struttura offrendo al tavolo un'immagine di grande leggerezza. Realizzato in plastica rotazionale, è disponibile nelle varianti nero, bianco, cipria e grigio lavanda.

The small table App, mainly intended for outdoor use, is ideal for versatile wide functions. Slender and sophisticated, it has a square top and four legs that converge at the top of the frame, enhancing the table with extreme lightness. Produced in rotational plastic, it is available in the variants black, white, carnation and lavender grey.







## lord yi

DESIGN \_ PHILIPPE STARCK

Il tavolino Lord Yi sorprende per la sua essenzialità e per la chiara composizione delle parti, volutamente segnalata nella sua tripartizione di base, fusto e piano.

Lord Yi table is surprising for its simplicity and the clear composition of the parties, deliberately signaled in his tripartite division of base, shaft and top.





**kissi kissi**  
**kissino**

DESIGN \_ MIKI ASTORI



Tavolino essenziale  
caratterizzato  
dalla plasticità  
delle forme.

Essential table  
characterized  
by malleable  
forms.



# Index

**sedie / chairs**



11 **costes**  
design Philippe Starck



15 **king costes**  
design Philippe Starck



16 **la francesa**  
design Lievore  
Altherr Molina



21 **lou eat**  
design Philippe Starck  
with D. Sugasawa



26 **miss lacy**  
**50 Limited Edition**  
design Philippe Starck



29 **miss lacy**  
design Philippe Starck



30 **soirée**  
design Oscar  
e Gabriele Buratti



36 **mingx**  
design Konstantin Grcic



41 **meridiana**  
design Christophe Pillet



44 **lago'**  
design Philippe Starck



48 **liba**  
design Borek Sipek



51 **neoz**  
design Philippe Starck



52 **sof sof**  
design Enzo Mari



55 **ed archer**  
design Philippe Starck



58 **blocco**  
design Nanda Vigo

**tavoli e tavolini / tables and coffee tables**



63 **frate**  
design Enzo Mari



66 **fratello**  
design Enzo Mari



71 **cugino**  
design Enzo Mari



72 **cuginetto**  
design Enzo Mari



75 **françois**  
design Lievore Altherr



80 **fourdrops**  
design Oscar  
e Gabriele Buratti



87 **easel**  
design Ludovica + Roberto Palomba



91 **anapo**  
design Gordon Guillaumier



96 **didymos**  
design Antonia Astori



102 **mingx**  
design Konstantin Grcic

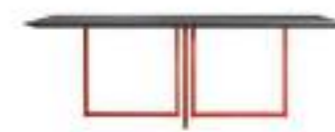

104 **gazelle**  
design Park Associati



107 **meridiana**  
design Christophe Pillet



109 **neoz**  
design Philippe Starck



110 **lybra**  
design Elliott Littman



112 **torquemada**  
design Philippe Starck



132 **psiche**  
design Philippe Starck



134 **ping I, II**  
design Giuseppe Chigiotti



135 **picapica**  
design Kazuyo Sejima



137 **mak**  
design Giuseppe Chigiotti



114 **koishi**  
design Naoto Fukasawa



117 **sereno**  
design Fredrikson Stallard



118 **carmina**  
design Ludovica + Roberto Palomba



121 **basalt**  
design Fredrikson Stallard



122 **ci**  
design Naoto Fukasawa



124 **zagzig**  
design DriadeLab



140 **ziqurat**  
design DriadeLab



149 **ercole e afrodite**  
design DriadeLab



154 **venus**  
design Fabio Novembre



127 **waterfall**  
design Fredrikson Stallard



129 **portable atelier**  
design Philippe Nigro



131 **still life**  
design Francesco Librizzi



157 **zigzag**  
design Konstantin Grcic



161 **virgo**  
design Xavier Lust

**contenitori e librerie / cabinets and bookcases**



**complementi d'arredo** / furnishing accessories



164 **nemo miniatura**  
design Fabio Novembre



167 **hanahana**  
design Kazuyo Sejima



168 **acate**  
design Borek Sipek



189 **twist**  
design Front Design



190 **no frame**  
design Antonia Astori



193 **miro**  
design Francesco Bolis



171 **norma**  
design Borek Sipek



172 **apollonio**  
design Borek Sipek



175 **lampsi**  
design Park Associati



194 **archipelago**  
design Fredrikson Stallard



196 **egeso**  
design Bertocco & Locatelli



197 **taylor and snijder bird**  
design Ed Annink



176 **cut**  
design Ludovica + Roberto Palomba



178 **la bruyere**  
design Linde Burkhardt



181 **la fontaine**  
design Linde Burkhardt



198 **osmond**  
design Pietro Derossi



201 **erbale**  
design Becchelli, Bortolani, Maffei



182 **maud I, II, Mildred I, II**  
design Antonia Astori



185 **yaschilan**  
design Vittorio Locatelli



186 **uragano**  
design Ludovica + Roberto Palomba

**poltrone e divani** / armchairs and sofas



205 **lou read**  
design Philippe Starck  
with Eugeni Quitlet



209 **lou speak**  
design Philippe Starck



213 **nemo**  
design Fabio Novembre



230 **meran**  
design Matteo Thun  
& Antonio Rodriguez



232 **moor(e)**  
design Philippe Starck



235 **s.marco**  
design Matteo Thun  
& Antonio Rodriguez



215 **moon**  
design Ludovica + Roberto Palomba



219 **full moon**  
design Ludovica + Roberto Palomba



220 **cinemascope**  
design Philippe Starck



236 **s.marco lounge**  
design Matteo Thun  
& Antonio Rodriguez



241 **pavo, pavo real**  
design Patricia Urquiola



242 **suki**  
design Toyo Ito



225 **viglius**  
design Matteo Thun & Antonio Rodriguez



226 **ten**  
design Naoto Fukasawa



229 **lisa**  
design Laudani & Romanelli



247 **wow, wow low back**  
design Philippe Starck



253 **fenix**  
design Ludovica + Roberto Palomba



256 **lirico**  
design Ludovica + Roberto Palomba



261 **lirica**  
design Ludovica + Roberto Palomba



263 **hall**  
design Rodolfo Dordoni



266 **megara**  
design Gordon Guillaumier



298 **garçonne**  
design Carlo Colombo



270 **neil**  
design Ludovica + Roberto Palomba



277 **33 cuscini**  
design Paolo Rizzatto



281 **leon soft**  
design Ludovica + Roberto Palomba

---

**letti / beds**



284 **rever**  
design Ludovica + Roberto Palomba



289 **verlaine**  
design Lievore Altherr Molina



290 **elisa**  
design Enzo Mari



302 **neoz**  
design Philippe Starck



304 **leon**  
design Ludovica + Roberto Palomba



307 **edward I, II, III, IV**  
design Antonia Astori



292 **mod**  
design Ludovica + Roberto Palomba



295 **mody**  
design Ludovica + Roberto Palomba



296 **neoz**  
design Philippe Starck

outdoor



311 **nemo**  
design Fabio Novembre



316 **roly poly** series  
design Faye Toogood



321 **tokyo-pop** series  
design Tokujin Yoshioka



345 **sissi**  
design Ludovica + Roberto Palomba



349 **pip-e**  
design Philippe Starck  
with Eugeni Quitllet



353 **toy**  
design Philippe Starck



327 **pliè**  
design Ludovica + Roberto Palomba



327 **gran pliè**  
design Ludovica + Roberto Palomba



327 **piaffè**  
design Ludovica + Roberto Palomba



355 **lord yo**  
design Philippe Starck



356 **bo**  
design Philippe Starck



359 **soft egg**  
design Philippe Starck



330 **mt 1, mt 2, mt 3** series  
design Ron Arad



334 **mingx** series  
design Konstantin Grcic



336 **camouflage** series  
design Fredrikson Stallard



361 **clover**  
design Ron Arad



363 **modesty veiled**  
design Italo Rota



364 **out/in**  
design Philippe Starck  
with Eugeni Quitllet



339 **elisa** series  
design Enzo Mari



341 **sunrise** series  
design Ludovica + Roberto Palomba



342 **herve'** series  
design Lievore Altherr Molina



367 **app**  
design Ludovica + Roberto Palomba



372 **lord yi**  
design Philippe Starck



375 **kissi kissi, kissino**  
design Miki Astori

## MASTHEAD

### **Art Direction**

DriadeLab

### **Photo**

Iacopo Barattieri

Max Zambelli

Francesco Bolis

Claudio Tajoli

Saverio Lombardi

Tom Vack

Lorenzo Cicconi Massi

Andrea Garuti

### **Thanks to**

Altai

Bisazza Spa

CC-Tapis Mazalli Srl

FontanaArte Spa

Gigacer Spa

Margaritelli Spa

Misha Wallpaper Srl

Par-Ky Italia Srl

Texidores SCCI

### **Print**

Nome Tipografia

November 2018

# driade

Alzaia Trieste, 49

20094 Corsico (MI), Italy

[driade.com](http://driade.com)

[@driade\\_it](mailto:@driade_it)



[driade.com](http://driade.com)